

Chevy Camaro 2010-2015 / Malibu 2016-up*

*Visit MetraOnline.com for up-to-date vehicle specific applications.

KIT FEATURES

- Provides spacing for aftermarket speaker installation

KIT COMPONENTS

- A) (2) Base Plates • B) (16) #8 x 3/4" Phillips Screws

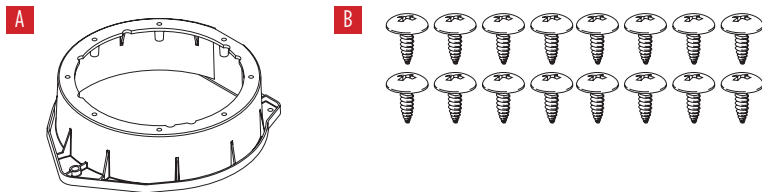

TABLE OF CONTENTS

Door Panel Disassembly.....	2
Kit Assembly	3

WIRING & ANTENNA CONNECTIONS (sold separately)

Wiring Harness: 72-5600

TOOLS REQUIRED

- Panel removal tool • Phillips screwdriver
- Socket wrench

CAUTION! All accessories, switches, climate controls panels, and especially air bag indicator lights must be connected before cycling the ignition. Also, do not remove the factory radio with the key in the on position, or while the vehicle is running.

DOOR PANEL DISASSEMBLY

1. Unclip and unplug the tweeter pod on the top of the door panel. (Figure A)
2. Remove the door handle bolt cover plate inside the door handle latch. (Figure B)
3. Remove (1) 9/32" bolt from behind cover plate. (Figure B)
4. Remove (1) T-27 Torx bolt from inside door pull cup. (Figure C)

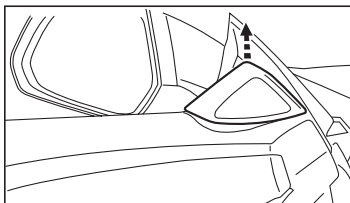

(Figure A)

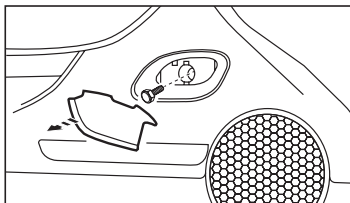

(Figure B)

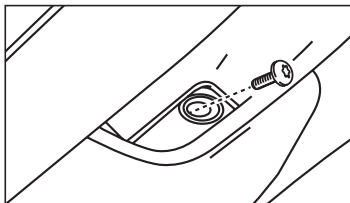

(Figure C)

5. Remove (3) 9/32" bolts from the edge of the door panel. (Figure D)
6. Unclip and remove the panel. (Figure D)
7. Unclip the door handle release cable from the panel. (Figure E)
8. Remove (1) 9/32" bolt from the top of the speaker and pull from the top to remove the speaker from the door. (Figure F)

Continue to Kit Assembly

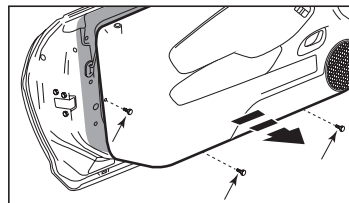

(Figure D)

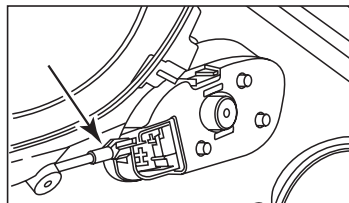

(Figure E)

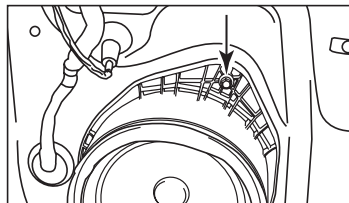

(Figure F)

KIT ASSEMBLY

1. Secure the base plate to the panel using the factory hardware.

Note: There are (2) screw holes on the bottom clip side of the base plate for added mounting reinforcement. (Figure A)

2. Secure the speaker to the ring mount either using the hardware supplied with the speaker or (4) of the supplied Phillips screws. (Figure B)

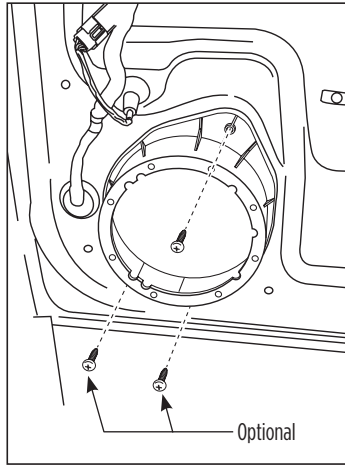

(Figure A)

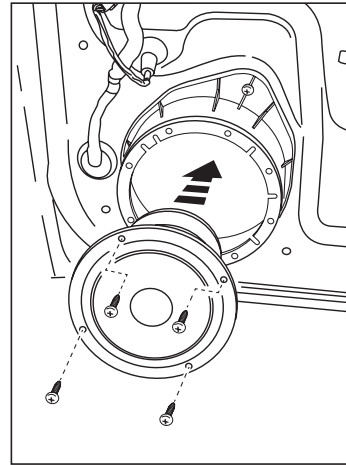

(Figure B)



82-3010
INSTALLATION INSTRUCTIONS



IMPORTANT

If you are having difficulties with the installation of this product, please call our Tech Support line at 1-800-253-TECH. Before doing so, look over the instructions a second time, and make sure the installation was performed exactly as the instructions are stated. Please have the vehicle apart and ready to perform troubleshooting steps before calling.



KNOWLEDGE IS POWER

Enhance your installation and fabrication skills by enrolling in the most recognized and respected mobile electronics school in our industry. Log onto www.installerinstitute.com or call 800-354-6782 for more information and take steps toward a better tomorrow.



**Metra recommends MECP
certified technicians**

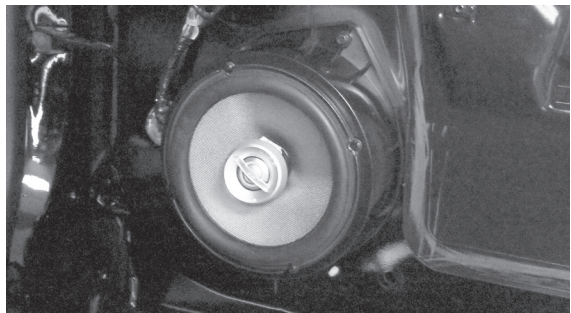

Chevy Camaro 2010-2015 / Malibu 2016 y mas*

* Visite MetraOnline.com para aplicaciones específicas de vehículos actualizadas.

CARACTERÍSTICAS DEL KIT

- Provee espaciamiento para la instalación de bocinas de mercado secundario

COMPONENTES DEL KIT

- A) (2) Placas base • B) (16) Tornillos Phillips #8 de 3/4"

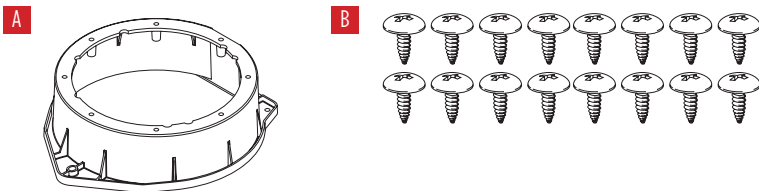

INDICE

Desmontaje del panel de la puerta	2
Ensamble del kit	3

CABLEADO Y CONEXIONES DE ANTENA

(Se venden por separado)

Arnés de cableado: 72-5600

HERRAMIENTAS REQUERIDAS

- Herramienta para quitar paneles • Destornillador Phillips • llave de tubo

¡PRECAUCIÓN! Todos los accesorios, interruptores, paneles de controles de clima y especialmente las luces del indicador de las bolsas de aire deben estar conectados antes de ciclar la ignición. Además, no quite el radio de fábrica con la llave en la posición de encendido ni con el vehículo funcionando.

DESMONTAJE DEL PANEL DE LA PUERTA

1. Desenganche y desconecte la cápsula de la bocina de alta frecuencia de la parte superior del panel de la puerta. (Figura A)
2. Quite la placa de cubierta del perno de la manija de la puerta de adentro del cerrojo de la manija de la puerta. (Figura B)
3. Quite (1) perno de 9/32" de atrás de la placa de cubierta. (Figura B)
4. Quite (1) perno T-27 Torx de adentro del hueco para jalar la puerta. (Figura C)

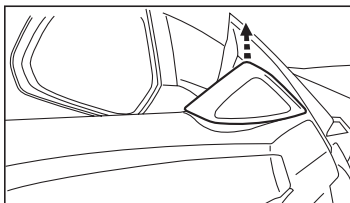

(Figura A)

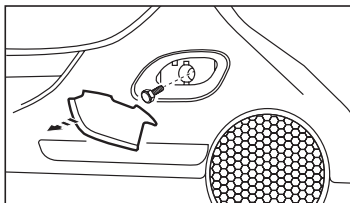

(Figura B)

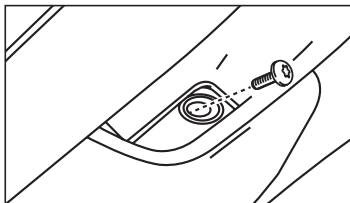

(Figura C)

5. Quite los (3) pernos de 9/32" del borde del panel de la puerta. (Figura D)
6. Desenganche y quite el panel. (Figura D)
7. Desenganche el cable de liberación de la manija de la puerta del panel. (Figura E)
8. Quite (1) perno de 9/32" de la parte superior de la bocina y jale desde arriba para quitar la bocina de la puerta. (Figura F)

Continuará la Ensamble del Kit

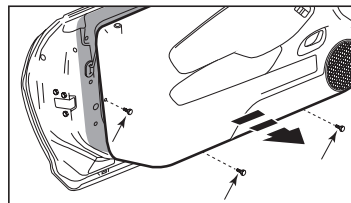

(Figura D)

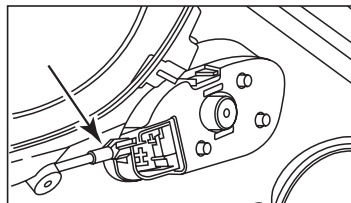

(Figura E)

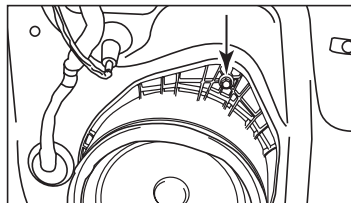

(Figura F)

ENSAMBLE DEL KIT

1. Sujete la placa base en el panel con los tornillos de fábrica.

Nota: Hay (2) orificios para tornillos en el lado del gancho inferior de la placa base para refuerzo adicional del montaje. (Figura A)

2. Sujete la bocina al montaje de aro ya sea utilizando los tornillos suministrados con la bocina o (4) de los tornillos Phillips suministrados. (Figura B)

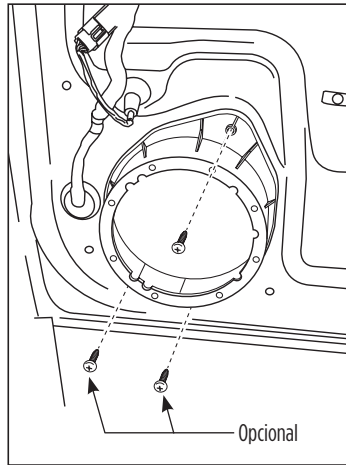

(Figura A)

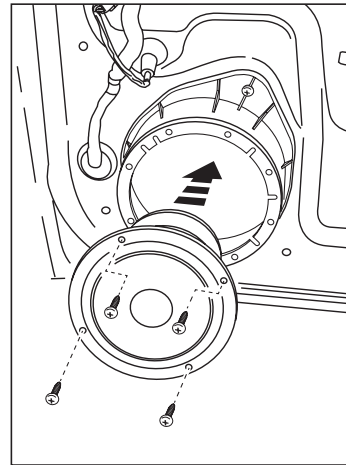

(Figura B)



82-3010

INSTRUCCIONES DE INSTALACIÓN



IMPORTANTE

Si tiene dificultades con la instalación de este producto, llame a nuestra línea de soporte técnico al 1-800-253-TECH. Antes de hacerlo, revise las instrucciones por segunda vez y asegúrese de que la instalación se haya realizado exactamente como se indica en las instrucciones. Por favor tenga el vehículo desarmado y listo para ejecutar los pasos de resolución de problemas antes de llamar.



EL CONOCIMIENTO ES PODER

Mejore sus habilidades de instalación y fabricación inscribiéndose en la escuela de dispositivos electrónicos móviles más reconocida y respetada de nuestra industria. Regístrese en www.installerinstitute.com o llame al 800-354-6782 para obtener más información y avance hacia un futuro mejor.



Metra recomienda técnicos con certificación del Programa de Certificación en Electrónica Móvil (Mobile Electronics Certification Program, MECP).