



INSTALLATION INSTRUCTIONS FOR PART 95-7320

APPLICATIONS

Hyundai Sonata 2006-2008

95-7320

KIT FEATURES

- Double DIN Radio Provision
- Stacked ISO Mount Units Provision

KIT COMPONENTS

A) Double DIN Trim Plate B) Double DIN Brackets

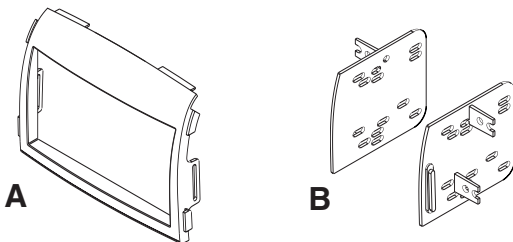

TOOLS REQUIRED:

- Small Flat Blade Screwdriver
- Panel Removal Tool
- Phillips Screwdriver



1-800-221-0932



www.metraonline.com

© COPYRIGHT 2007 METRA ELECTRONICS CORPORATION



TABLE OF CONTENTS

Dash Disassembly

- Hyundai Sonata 2006- 2008 1

Kit Assembly

- Double DIN or Stacked ISO Mount Units Provision 2

Final Assembly 3

***Note:**

Refer also to the instructions included with the aftermarket radio.

HYUNDAI SONATA 2006-2008

- 1 Disconnect the negative battery terminal to prevent an accidental short circuit.
- 2 Open glove box and remove (2) Phillips screws from top edge of glove box opening and bottom edge of wood trim below radio. (Figure A)
- 3 Unclip and remove wood trim from below radio and above glove box. (Figure B)
- 4 Remove (1) Phillips screw securing each side panel next to radio then unclip and remove the panels. (Figure C)
- 5 Remove (6) Phillips screws securing the radio. Unplug and remove the radio. (Figure D)

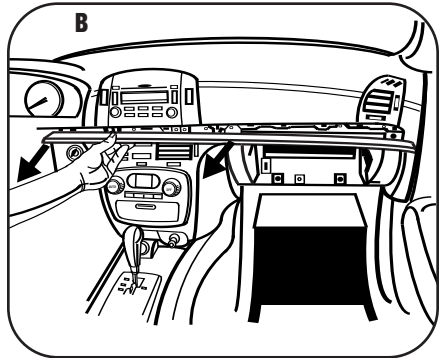
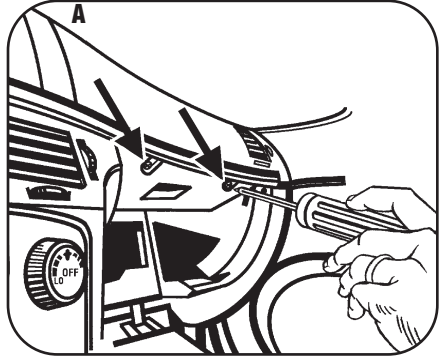

NOTE: There is a factory support bracket in the bottom of the radio cavity that may need to be pushed out of the way for the aftermarket radio to fit properly.

Continue to kit assembly.

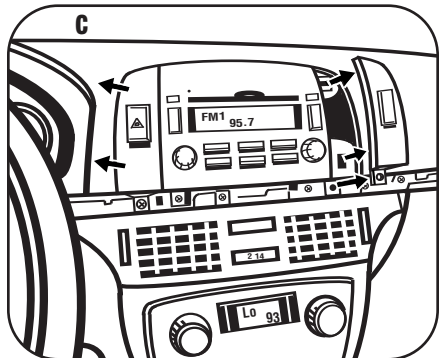
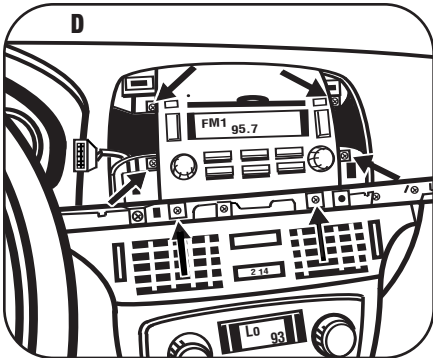

DOUBLE DIN OR STACKED ISO MOUNT UNITS PROVISION

**Note: Refer also to the instructions included with the aftermarket radio.*

- 1 Snap the Double DIN brackets to the inside edge of the Double DIN Trim Plate. (Figure A)
- 2 Slide the Double DIN or stacked ISO mount unit(s) into the bracket/trim plate assembly and secure the unit(s) to the assembly using the screws supplied with the unit(s). (Figure B)

Continue to final assembly.

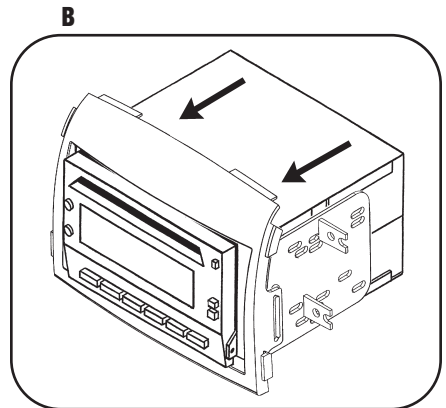
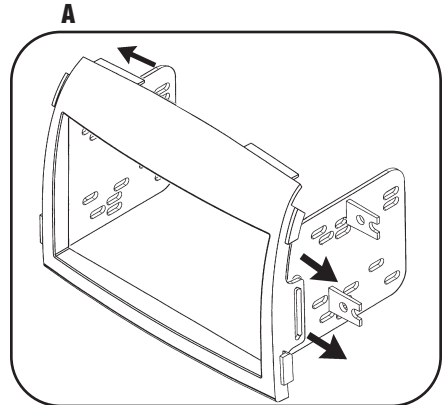

FINAL ASSEMBLY

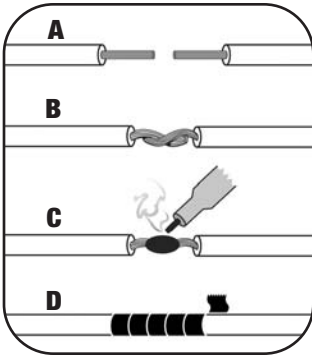

- (A) Strip wire ends back 1/2"**
- B) Twist ends together**
- C) Solder**
- D) Tape**

- 1** Locate the factory wiring harness in the dash. Metra recommends using the proper mating adapter and making connections as shown. (Isolate and individually tape off the ends of any unused wires to prevent electrical short circuit.)
- 2** Re-connect the negative battery terminal and test the unit for proper operation.
- 3** Reassemble radio and dash assemblies in reverse order of disassembly.

FINAL WIRING CONNECTIONS

Make wiring connections using the EIA color code chart shown below and the instructions included with the head unit. Metra recommends making connections as shown below; Strip, Splice, Solder, Tape. Isolate and individually tape off ends of any unused wires to prevent electrical short circuit.

METRA / EIA WIRING CODE

12V Ignition / Acc.	Red	Right Front (+)	Gray
12V Batt / Memory	Yellow	Right Front (-)	Gray/ Black
Ground	Black*	Left Front (+)	White
Power Antenna	Blue	Left Front (-)	White / Black
Amp Turn-On	Blue / White	Right Rear (+)	Violet
Amp Ground	Black / White	Right Rear (-)	Violet / Black
Illumination	Orange	Left Rear (+)	Green
Dimmer	Orange / White	Left Rear (-)	Green / Black

***NOTE:** When a Black wire is not present, ground radio to vehicle chassis.
All colors may not be present on all leads due to manufacturer's specifications.

95-7320 INSTRUCTIONS



1-800-221-0932  **www.metraonline.com**

Rev. 12/31/07 © COPYRIGHT 2007 METRA ELECTRONICS CORPORATION INST95-7320