



Nissan Multi-kit 2007-2021

(see application list on page 2)

Visit MetraOnline.com for more detailed information about the product and up-to-date vehicle specific applications

KIT FEATURES

- ISO DDIN radio provision

KIT COMPONENTS

- A) Radio housing trim panel, standard • B) Radio housing trim panel, wide • C) Bracket #1 • D) Bracket #2 • E) Bracket #3 • F) Spacers

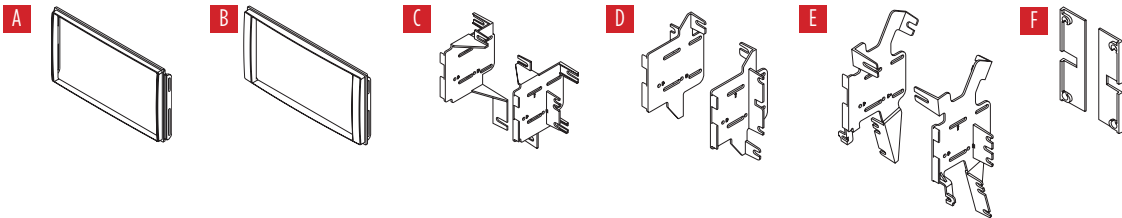

TABLE OF CONTENTS

(see page 2)

WIRING & ANTENNA CONNECTIONS (sold separately)

Wiring Harness: 70-7552

Antenna Adapter: 40-N112

TOOLS REQUIRED

- Panel removal tool • Phillips screwdriver

Attention! With the key out of the ignition, disconnect the negative battery terminal before installing this product. Ensure that all installation connections are secure before cycling the ignition to test this product.

APPLICATIONS

Chevrolet

City Express 2015-2018

Nissan

Cube 2009-2014

Frontier 2016-2021

Frontier (all except S trim with King Cab) 2013-2015

Juke 2011-2017

NV 2012-2021

NV200 2013-2021

Quest (without NAV or rear seat entertainment) 2011-2016

Rogue (S with Special Edition Package) 2012-2013

Rogue (SV) 2012-2013

Rogue Select (with 4.3" screen) 2014-2015

Titan (all except S trim) 2013-2015

Versa 2007-2019

Versa Note 2014-2019

Xterra 2014-2015

Xterra (with 4.3" screen) 2013

TABLE OF CONTENTS

Dash Disassembly

Chevrolet

- City Express 2015-2018 6

Nissan

- Cube 2009-2014 3

- Frontier/Xterra (with 4.3" screen) 2013-2021 3

- Juke 2011-2017 4

- NV 2012-2021 5

- NV200 2013-2021 6

- Quest (without NAV or rear seat entertainment) 2011-2016 7-8

- Rogue (S with Special Edition Package), Rogue SV 2012-2013 9

- Rogue Select (with 4.3" screen) 2014-2015 9

- Titan (all except S trim) 2013-2015 10

- Versa 2007-2019 10-11

- Versa Note 2014-2019 11

- Xterra 2014-2015 3

- Xterra (with 4.3" screen) 2013 3

Kit Assembly

- Radio housing trim panel usage 12

- Bracket tab layouts 13-15

- ISO DIN radio provision with pocket 16

- ISO DDIN radio provision 17

DASH DISASSEMBLY

Nissan Cube 2009-2014

1. Remove (2) Phillips screws from the bottom of the a/c trim panel then unclip and remove the panel. (Figure A,B)
2. Remove (2) Phillips screws from the bottom of the radio trim panel then unclip and remove the panel. (Figure C)
3. Remove (4) Phillips screws securing radio to dash to remove.

Continue to Kit Assembly

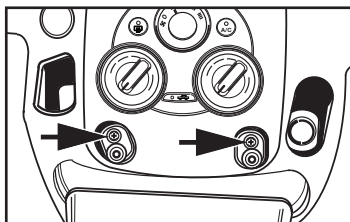

(Figure A)

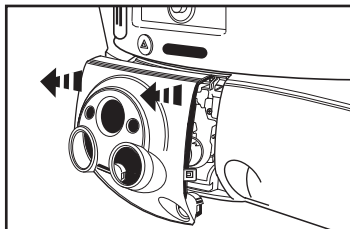

(Figure B)

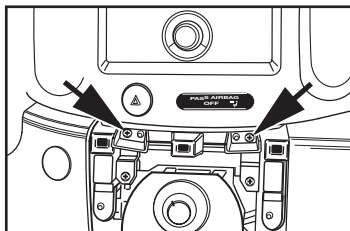

(Figure C)

Nissan Frontier 2013-2021

Nissan Xterra 2014-2015

Nissan Xterra (with 4.3" screen) 2013

1. Unclip and remove the trim panel above the radio and climate controls. (Figure A)
2. Remove the (1) Phillips screw under panel and the (2) Phillips screws securing the radio brackets to the sub dash. (Figure B)
3. Unclip and remove the entire panel including the climate controls and factory radio.
4. Remove (4) Torx screws securing the radio to the trim panel. (Figure C, D)

Continue to Kit Assembly

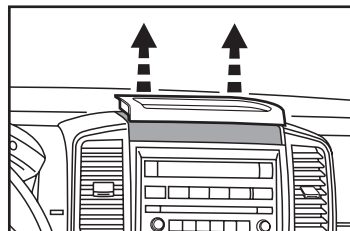

(Figure A)

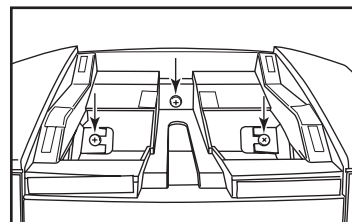

(Figure B)

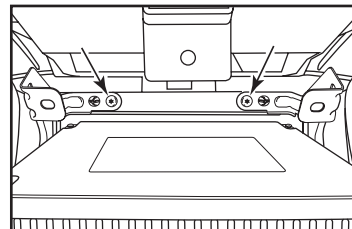

(Figure C)

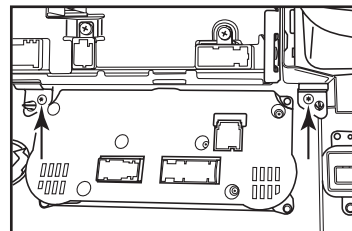

(Figure D)

DASH DISASSEMBLY

Nissan Juke 2011-2017

For manual climate controls:

1. Lift up to remove the small knob on the slide for “recirc/ fresh air”.
2. Unsnap and remove the trim from around the climate controls (controls stay in the dash). (Figure A-1)
3. Remove (2) Phillips screws securing the radio trim panel. (Figure B)
4. Remove (4) Phillips screws securing the radio, unplug and remove radio. (Figure C)

Continue to Kit Assembly

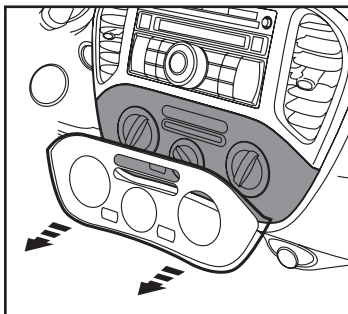

(Figure A-1)

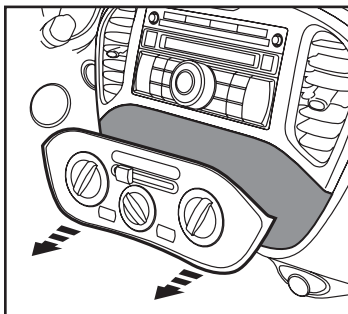

(Figure A-2)

For auto climate controls:

1. Unclip and remove the climate control panel. (Figure A-2)
2. Remove (2) Phillips screws securing the radio trim panel. (Figure B)
3. Remove (4) Phillips screws securing the radio, unplug and remove radio. (Figure C)

Continue to Kit Assembly

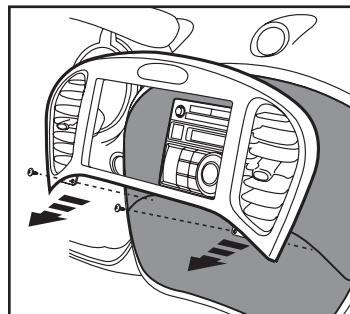

(Figure B)

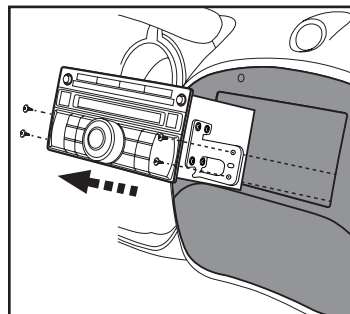

(Figure C)

DASH DISASSEMBLY

Nissan NV 2012-2021

1. Unclip and remove the A/C vent to the right side of the factory radio. (Figure A)
2. Remove the (2) Phillips screws exposed behind vent on radio trim panel. (Figure B)
3. Unclip and remove the left A/C vent next to the instrument display. (Figure C)
4. Unclip the top edge of the knee bolster panel below the steering column and let hang. (Figure D)

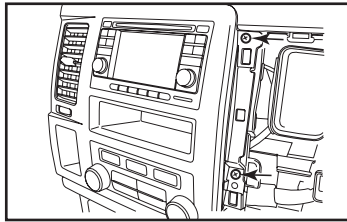

(Figure B)

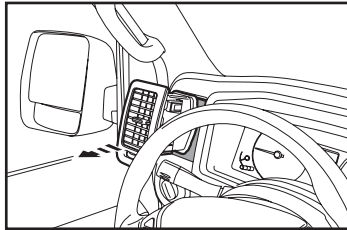

(Figure C)

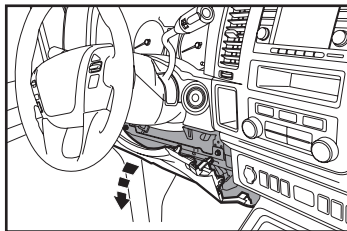

(Figure D)

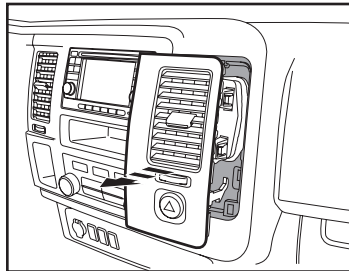

(Figure A)

5. Unclip the circle trim around the key cylinder. (Figure E)
6. Unclip and remove the gauge cluster trim panel. (Figure F)
7. Remove (2) Phillips screws exposed behind the panel on the left side of the radio trim panel. (Figure F)
8. Unclip and remove the trim panel surrounding the factory radio. (Figure G)
9. Remove (4) Phillips screws securing the radio. (Figure H)

Continue to Kit Assembly

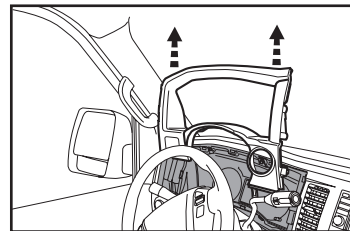

(Figure E)

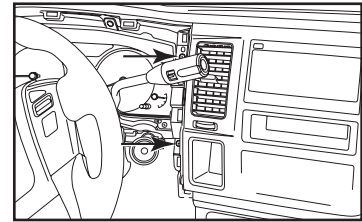

(Figure F)

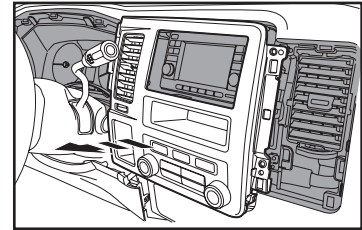

(Figure G)

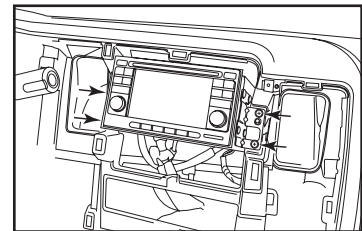

(Figure H)

DASH DISASSEMBLY

Chevrolet City Express 2015-2018

Nissan NV200 2013-2021

1. Unclip and remove the recirculate/fresh slide button. (Figure A)
2. Unclip and remove the entire panel surrounding the radio including the a/c vents. (Figure B)
3. Remove (4) Phillips screws securing the radio. (Figure C)

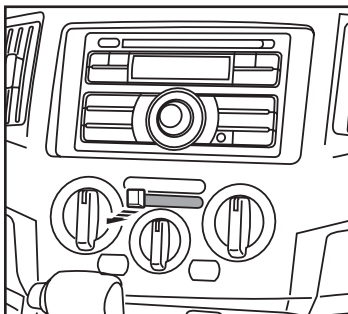

(Figure A)

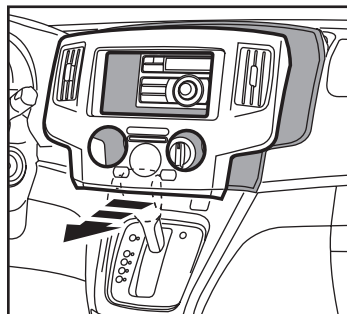

(Figure B)

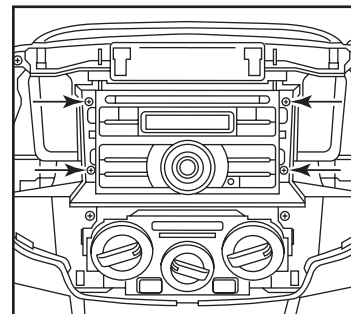

(Figure C)

Continue to kit assembly

DASH DISASSEMBLY

Nissan Quest

(without NAV or rear seat entertainment)

2011-2016

1. Unclip and remove the panels from the bottom left and right side of the center console. (Figure A)
2. Remove (2) clips per side exposed behind lower panels. (Figure B)
3. Unclip and pull center console toward rear of vehicle. (Figure C)

Note: You do not have to fully remove console. (Figure C)

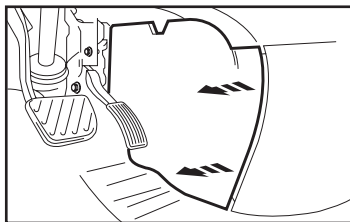

(Figure A)

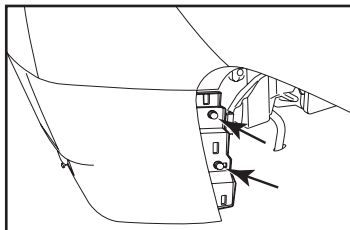

(Figure B)

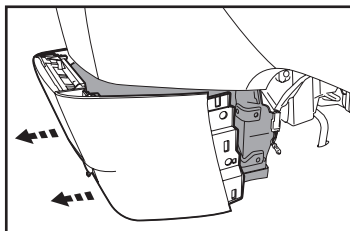

(Figure C)

4. Unclip and remove the trim panel to the left of the shifter housing the start/stop button. (Figure D)
5. Unclip and remove the panel on the end of the passenger side of the dash. (Figure E)
6. Remove (1) Phillips screw from the trim panel above the glove box then unclip and remove the panel. (Figure F)

Continued on next page

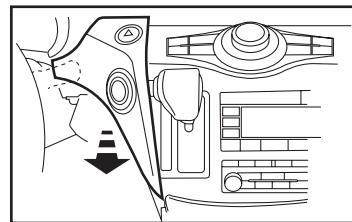

(Figure D)

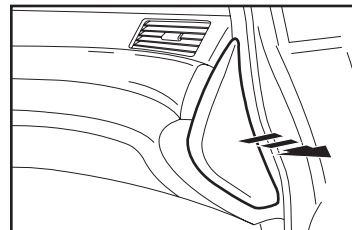

(Figure E)

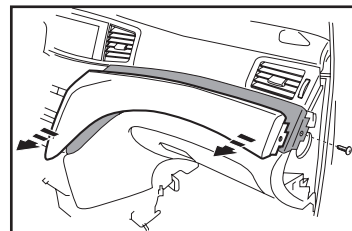

(Figure F)

DASH DISASSEMBLY (CONT.)

Nissan Quest

(without NAV or rear seat entertainment)

2011-2016 (Cont)

7. Remove (1) Phillips screw from the cup holder panel then unclip and remove the panel. (Figure G)
8. Remove (2) Phillips screws from the a/c control panel and unclip and let hang. (Figure H)
9. Remove (2) Phillips screws from the bottom of the radio trim panel including the vents then unclip and remove the panel. (Figure H)
10. Remove (4) Phillips screws securing the radio. (Figure I)

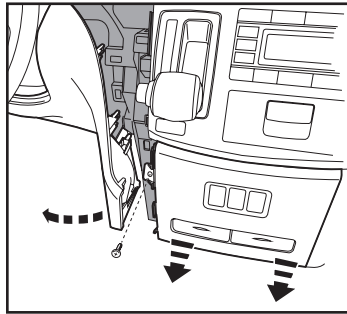

(Figure G)

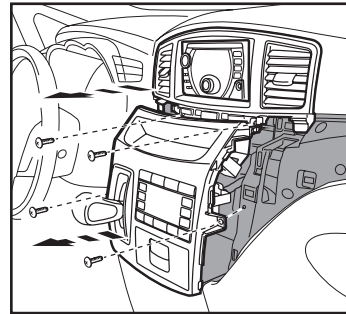

(Figure H)

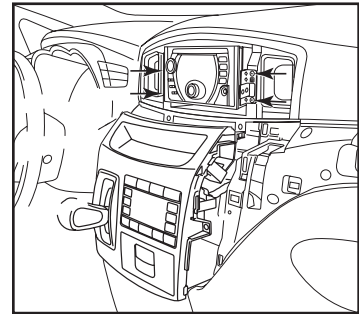

(Figure I)

Continue to Kit Assembly

DASH DISASSEMBLY

Nissan Rogue

(S with Special Edition Package) 2011-2013

Nissan Rogue SV 2012-2013

Nissan Rogue Select (with 4.3" screen)
2014-2015

1. If equipped with center speaker: Unclip and remove the grille then remove (4) Phillips screws to remove the speaker. (Figure A)
2. Unclip and remove the panel below the radio including the a/c controls. (Figure B)

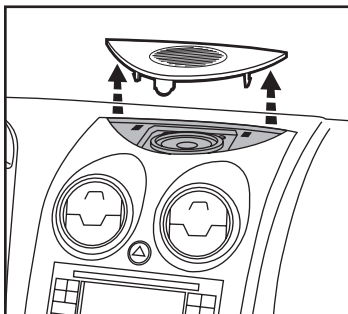

(Figure A)

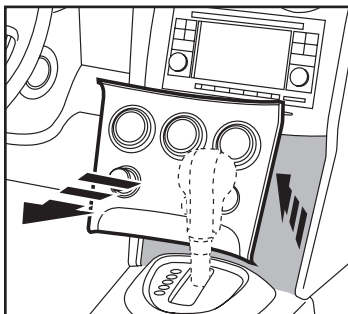

(Figure B)

3. Unclip the radio trim including the a/c vents then unplug the hazard switch and remove the panel. (Figure C)
4. Remove (4) Phillips screws securing the radio. (Figure D)

Continue to kit assembly

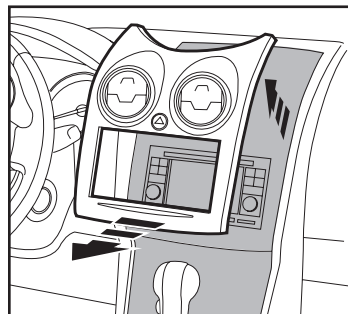

(Figure C)

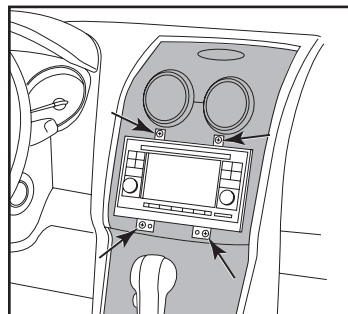

(Figure D)

DASH DISASSEMBLY

Nissan Titan (all except S trim) 2013-2015

1. Unclip the entire dash panel including the climate controls. Unplug and remove the panel. (Figure A)
2. Remove (4) Phillips screws securing the radio. Unplug and remove the chassis. (Figure B)

Continue to Kit Assembly

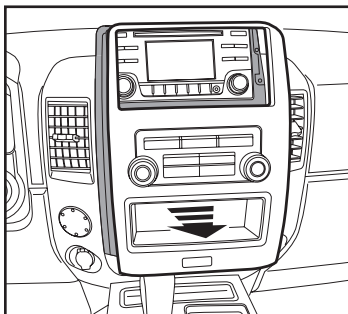

(Figure A)

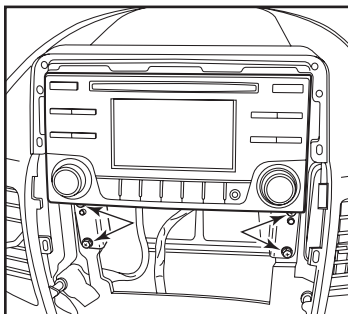

(Figure B)

Nissan Versa 2007-2011

1. Unclip and remove the panel above the radio. (Figure A, B)
2. Remove (2) Phillips screws securing the radio trim panel then unclip and remove the entire panel surrounding the radio and A/C controls. (Figure C)
3. Remove (4) Phillips screws securing radio, unplug and remove radio. (Figure D)

Continue to Kit Assembly

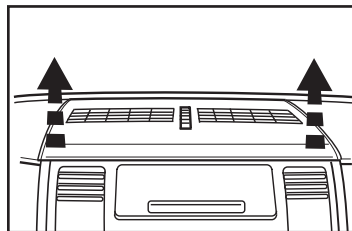

(Figure A)

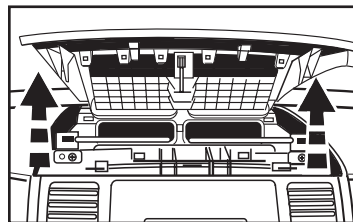

(Figure B)

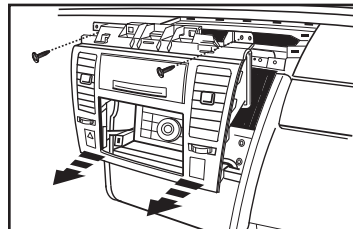

(Figure C)

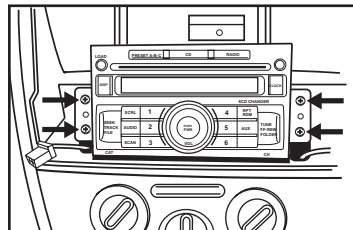

(Figure D)

DASH DISASSEMBLY

Nissan Versa 2012-2019

Nissan Versa Note 2014-2019

1. Unclip and remove the entire panel surrounding the radio including the A/C vents. (Figure A)
2. Remove (4) Phillips screws securing the radio. (Figure B)

Continue to Kit Assembly

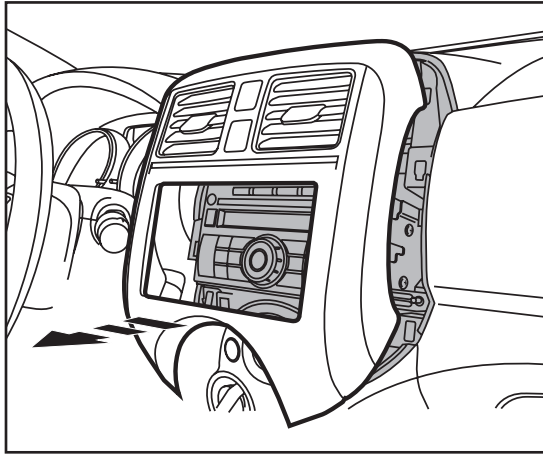

(Figure A)

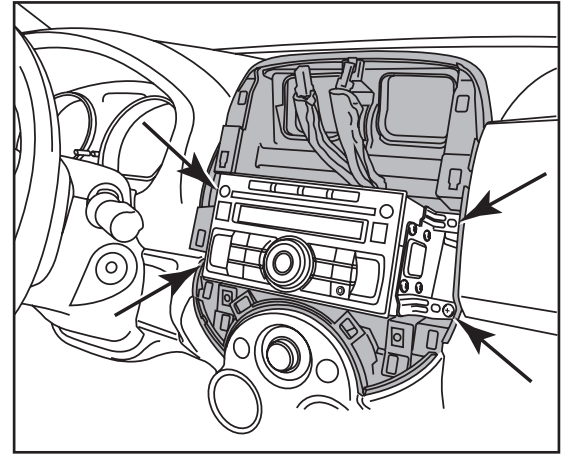

(Figure B)

KIT ASSEMBLY

Radio housing trim panel usage

Vehicle	Trim panel
Chevrolet City Express (without NAV) 2015-2018	Standard
Chevrolet City Express (with NAV) 2015-2018	Wide
Nissan Cube 2009-2014	Standard
Nissan Frontier (with 4.3" screen) 2013-2021	Wide
Nissan Juke 2011-2014	Standard
Nissan Juke 2015-2017	Wide
Nissan NV 2012-2021	Standard
Nissan NV (without NAV) 2015-2021	Standard
Nissan NV (with NAV) 2015-2021	Wide
Nissan NV200 (without NAV) 2013-2021	Standard
Nissan NV200 (with NAV) 2013-2021	Wide
Nissan Quest (without NAV or rear seat entertainment) 2011-2012	Standard
Nissan Quest (without NAV or rear seat entertainment) 2013-2016	Wide
Nissan Rogue Select (with lower model radio) 2014-2015	Standard
Nissan Rogue Select (with upper model radio) 2014-2015	Wide

Vehicle	Trim panel
Nissan Rogue S (with Special Edition Package) 2012-2013	Wide
Nissan Rogue SV 2012-2013	Wide
Nissan Rogue S and SV (with SL Package) 2003-2007	Standard
Nissan Rogue 2011	Standard
Nissan Titan (all except S trim) 2013-2015	Wide
Nissan Versa 2007-2011	Standard
Nissan Versa 2012-2013	Standard

Vehicle	Trim panel
Nissan Versa S, S+ and SV (without options) 2014-2019	Standard
Nissan Versa Note 2014-2019	Wide
Nissan Versa SL and SV (with Convenience Package) 2014-2019	Wide
Nissan Versa and Versa Note (all models) 2015-2019	Wide
Nissan Xterra (with 4.3" screen) 2013	Wide

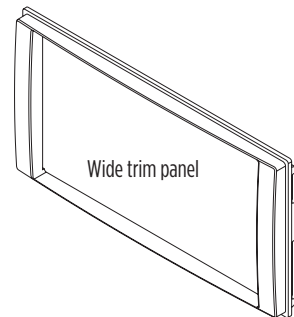
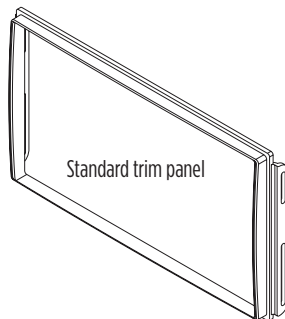

KIT ASSEMBLY

Bracket #1 tab layout

Bracket #	Tab	Vehicle
1	A	Versa 2012-2019
1	A	Versa Note 2014-2019
1	B	Rogue 2011-2013
1	B	Rogue Select 2014-2015
1	C	NV 2012-2021
1	C	Quest (without NAV or rear seat entertainment) 2011-2016

Note: It may be necessary to remove all unneeded tabs from the brackets for certain applications. Depending on the application it may also be necessary to trim the entire bracket as close as possible to the radio mounting locations on the brackets.

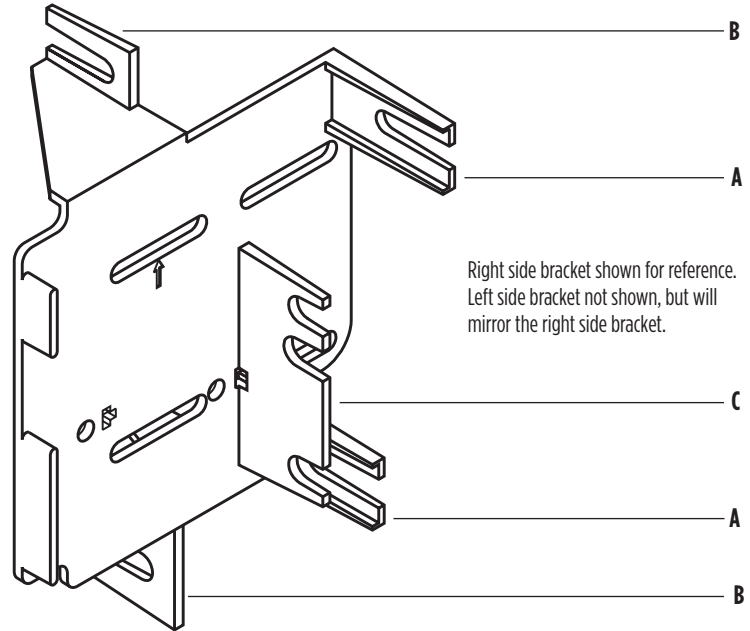

KIT ASSEMBLY

Bracket #2 tab layout

Bracket #	Tab	Vehicle
2	E	Chevrolet City Express 2015-2018
2	D	Nissan Juke 2011-2017
2	E	Nissan NV200 2013-2021
2	E	Nissan Cube (use spacers) 2009-2014

Note: It may be necessary to remove all unneeded tabs from the brackets for certain applications. Depending on the application it may also be necessary to trim the entire bracket as close as possible to the radio mounting locations on the brackets.

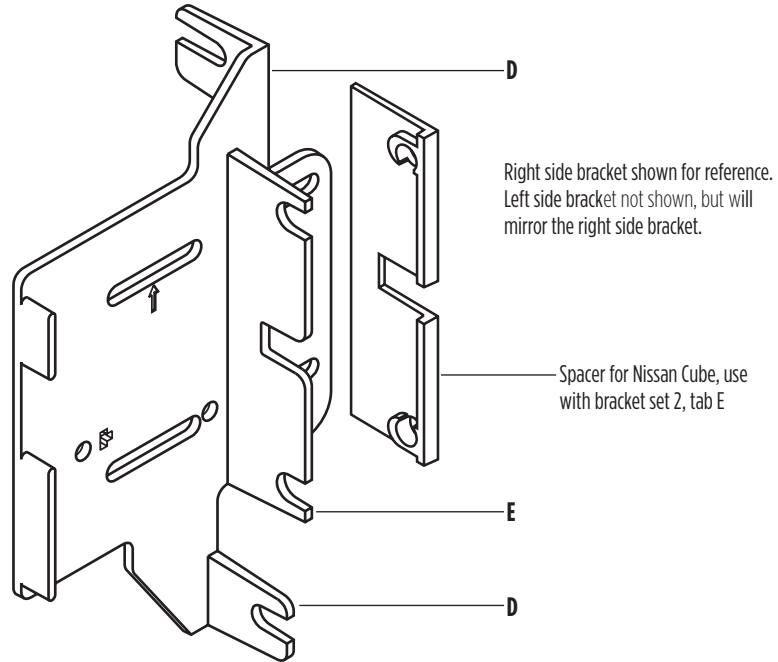

KIT ASSEMBLY

Bracket #3 tab layout

Bracket #	Tab	Vehicle	
3	F	Frontier (all except S trim with King Cab)	2013-2015
3	F	Xterra (with 4.3" screen)	2013
3	G	Titan (all except S trim)	2013-2015
3	H	Versa	2007-2019

Note: It may be necessary to remove all unneeded tabs from the brackets for certain applications. Depending on the application it may also be necessary to trim the entire bracket as close as possible to the radio mounting locations on the brackets.

1. Cut and remove the shaded area of the brackets for the 2013-2015 Frontier and Xterra. (Figure A)
2. Cut and remove the shaded area of the brackets for the Titan 2013-2015. (Figure A)

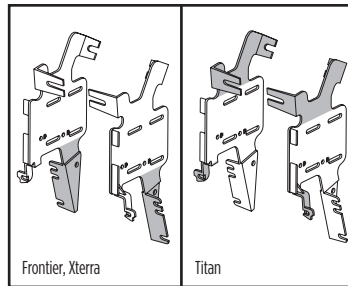

(Figure A)

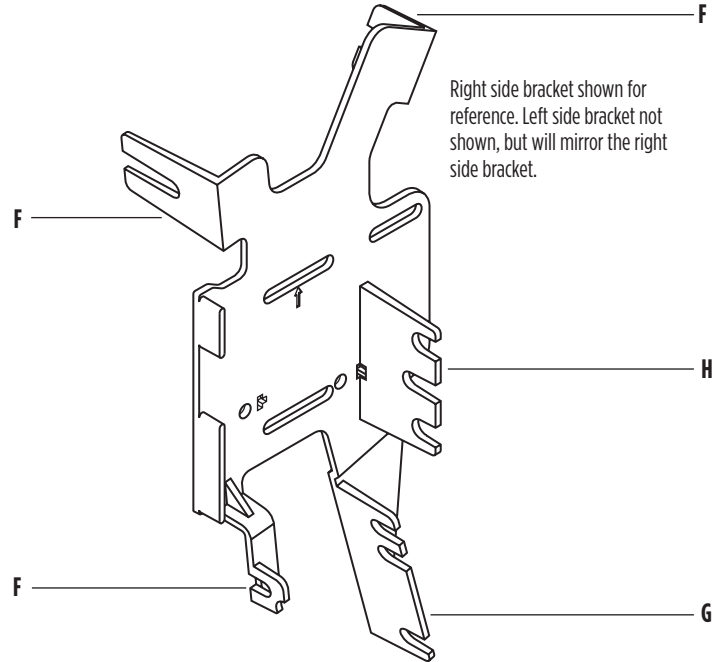

KIT ASSEMBLY

1. Attach your corresponding **bracket** to the **radio housing trim panel**. (Bracket #2 with the standard radio trim panel shown) (Figure A)
2. Slide the radio into the assembly and secure with screws supplied with the radio. (Figure B)
3. Locate the factory wiring harness and antenna plug in the dash. Metra recommends using the proper mating adapters from Metra and/or AXXESS.
4. Mount the new radio assembly into the dash and reassemble dash in reverse order of disassembly.

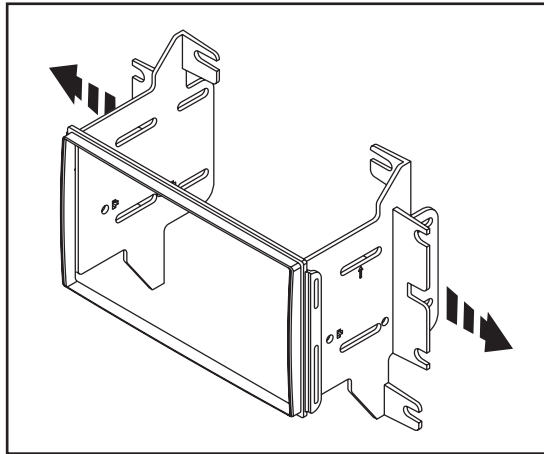

(Figure A)

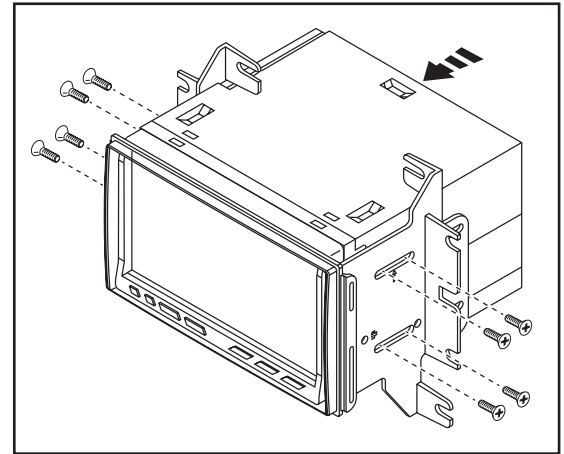

(Figure B)



95-7624
INSTALLATION INSTRUCTIONS



Having difficulties? We're here to help.



Contact our Tech Support line at:

386-257-1187



Or via email at:

techsupport@metra-autosound.com

Tech Support Hours (Eastern Standard Time)

Monday - Friday: 9:00 AM - 7:00 PM

Saturday: 10:00 AM - 7:00 PM

Sunday: 10:00 AM - 4:00 PM



KNOWLEDGE IS POWER

Enhance your installation and fabrication skills by enrolling in the most recognized and respected mobile electronics school in our industry. Log onto www.installerinstitute.edu or call 386-672-5771 for more information and take steps toward a better tomorrow.



**Metra recommends MECP
certified technicians**



Nissan Multi-kit 2007-2021

(ver la lista de aplicaciones de la página 2)

Visite MetraOnline.com para más información acerca del producto y las aplicaciones específicas más actualizadas del vehículo

CARACTERÍSTICAS DEL KIT

- Provisión de radio ISO DDIN

COMPONENTES DEL KIT

- A) Panel de moldura para la carcasa del radio, estándar
- B) Panel de moldura para la carcasa del radio, ancho
- C) Soporte #1
- D) Soporte #2
- E) Soporte #3
- F) Espaciadores

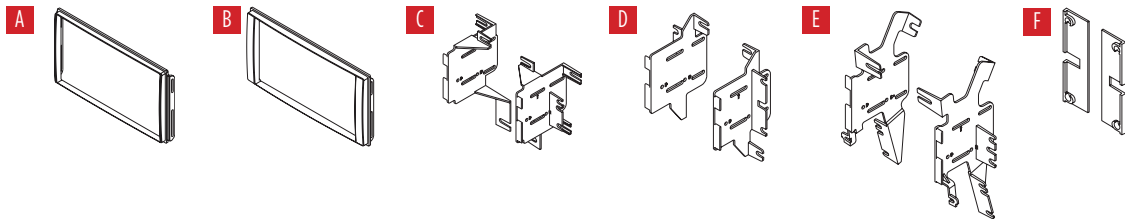

INDICE

Ver página 2

CABLEADO Y CONEXIONES DE ANTENA

(se venden por separado)

Arnés de cableado: 70-7552

Adaptador de antena: 40-NI12

HERRAMIENTAS NECESARIAS

- Herramienta para remoción de paneles
- Destornillador Phillips

¡Atención! Con la llave fuera del encendido, desconecte el terminal negativo de la batería antes de instalar este producto. Asegúrese de que todas las conexiones de la instalación estén seguras antes de encender y apagar el encendido para probar este producto.

APLICACIONES

Chevrolet

City Express 2015-2018

Nissan

Cube 2009-2014

Frontier 2016-2021

Frontier (todos excepto el acabado S con King Cab) 2013-2015

Juke 2011-2017

NV 2012-2021

NV200 2013-2021

Quest (sin NAV o entretenimiento para el asiento trasero) 2011-2016

Rogue (S con paquete de edición especial) 2012-2013

Rogue (SV) 2012-2013

Rogue Select (con pantalla de 4.3") 2014-2015

Titan (todos excepto el ajuste S) 2013-2015

Versa 2007-2019

Versa Note 2014-2019

Xterra 2014-2015

Xterra (con pantalla de 4.3") 2013

INDICE

Dash Disassembly

Chevrolet

- City Express 2015-2018 6

Nissan

- Cube 2009-2014 3

- Frontier/Xterra (con pantalla de 4.3") 2013-2021 3

- Juke 2011-2017 4

- NV 2012-2021 5

- NV200 2013-2021 6

- Quest (sin NAV o entretenimiento para el asiento trasero) 2011-2016 7-8

- Rogue (S con paquete de edición especial), Rogue SV 2012-2013 9

- Rogue Select (con pantalla de 4.3") 2014-2015 9

- Titan (todos excepto el ajuste S) 2013-2015 10

- Versa 2007-2019 10-11

- Versa Note 2014-2019 11

- Xterra 2014-2015 3

- Xterra (con pantalla de 4.3") 2013 3

Kit Assembly

- Radio housing trim panel usage 12

- Bracket tab layouts 13-15

- ISO DIN radio provision with pocket 16

- ISO DDIN radio provision 17

DESMONTAJE DEL TABLERO

Nissan Cube 2009-2014

1. Quite los (2) tornillos Phillips de la parte inferior del panel de la moldura del aire acondicionado y luego desenganche y retire el panel. (Figura A,B)
2. Quite los (2) tornillos Phillips de la parte inferior del panel de la moldura del radio y luego desenganche y retire el panel. (Figura C)
3. Quite los (4) tornillos Phillips que sujetan el radio al tablero y retire.

Continúe con el ensamble del kit

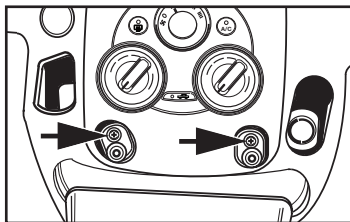

(Figura A)

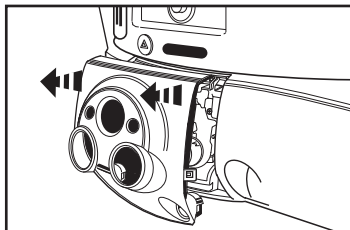

(Figura B)

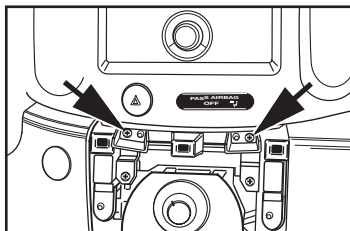

(Figura C)

Nissan Frontier 2013-2021

Nissan Xterra 2014-2015

Nissan Xterra (con pantalla de 4.3") 2013

1. Desenganche y quite el panel de moldura de arriba del radio y los controles del clima. (Figura A)
2. Quite el tornillo Phillips (1) de debajo del panel y los (2) tornillos Phillips que sujetan los soportes del radio al sub tablero. (Figura B)
3. Desenganche y quite todo el panel, incluyendo los controles del clima y el radio de fábrica.
4. Quite los (4) tornillos Torx que sujetan el radio al panel de la moldura. (Figura C, D)

Continúe con el ensamble del kit

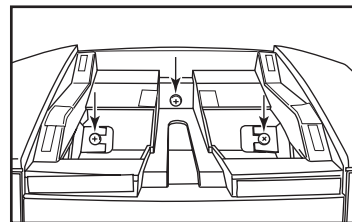

(Figura B)

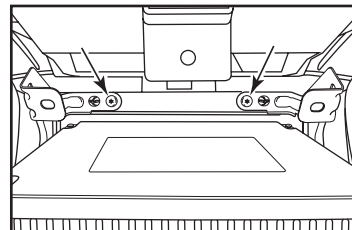

(Figura C)

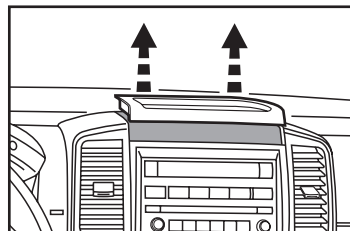

(Figura A)

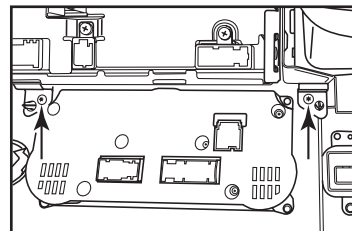

(Figura D)

DESMONTAJE DEL TABLERO

Nissan Juke 2011-2017

Para controles de clima manuales:

1. Levante para quitar la pequeña perilla de la corredera para “recirc / aire fresco”.
2. Desabroche y quite la moldura alrededor de los controles de clima (los controles permanecen en el tablero). (Figura A-1)
3. Quite los (2) tornillos Phillips que sujetan el panel de moldura del radio. (Figura B)
4. Quite (4) tornillos Phillips que sujetan la radio, desenchufe y quite la radio. (Figura C)

Continúe con el Ensamble del Kit

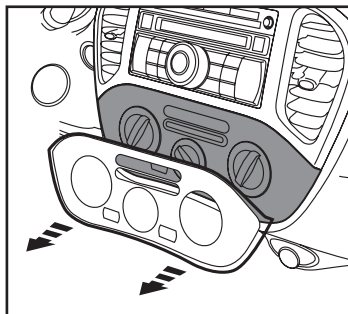

(Figura A-1)

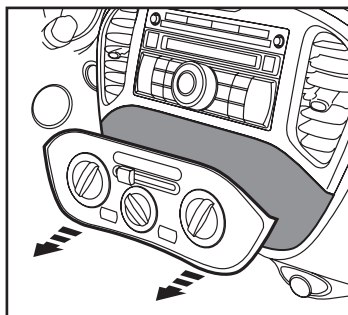

(Figura A-2)

Para controles de clima automático:

1. Desenganche y retire el panel de control del clima. (Figura A-2)
2. Quite (2) tornillos Phillips que sujetan el panel de moldura del radio. (Figura B)
3. Quite (4) tornillos Phillips que sujetan la radio, desenchufe y quite la radio. (Figura C)

Continúe con el Ensamble del Kit

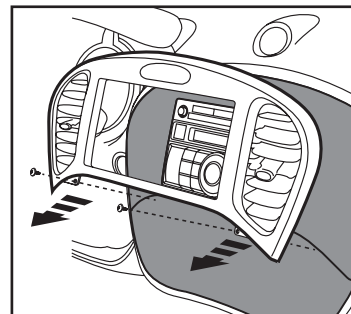

(Figura B)

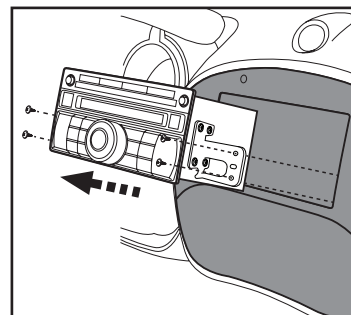

(Figura C)

DESMONTAJE DEL TABLERO

Nissan NV 2012-2021

1. Desenganche y quite la rejilla del aire acondicionado que está a la derecha del radio de fábrica. (Figura A)
2. Quite los (2) tornillos Phillips que quedan a la vista detrás de la rejilla en el panel de moldura del radio. (Figura B)
3. Desenganche y quite la rejilla del aire acondicionado que está a la izquierda de la pantalla de instrumentos. (Figura C)
4. Desenganche el borde de arriba del panel del refuerzo para rodillas de abajo de la columna de dirección y déjelo colgando. (Figura D)

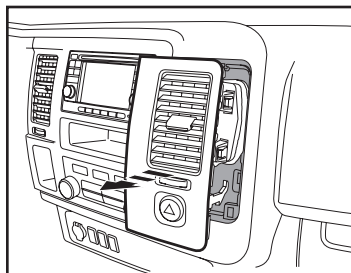

(Figura A)

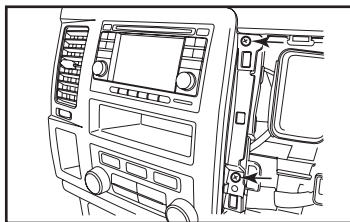

(Figura B)

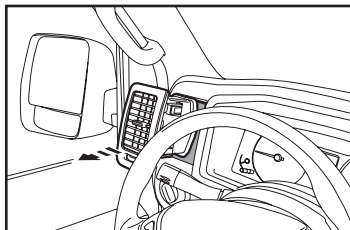

(Figura C)

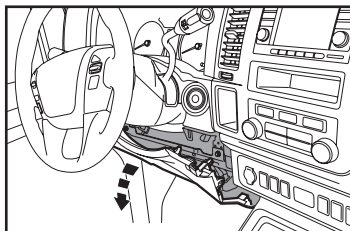

(Figura D)

5. Desenganche la moldura circular alrededor del cilindro de la llave.
6. Desenganche y quite el panel de la moldura del conjunto de indicadores. (Figura E)
7. Quite los (2) tornillos Phillips que quedan a la vista atrás del panel del lado izquierdo del panel de la moldura del radio. (Figura F)
8. Desenganche y retire el panel de moldura que rodea el radio de fábrica. (Figura G)
9. Retire los (4) tornillos Phillips que sostienen el radio. (Figura H)

Continúe con el ensamble del kit

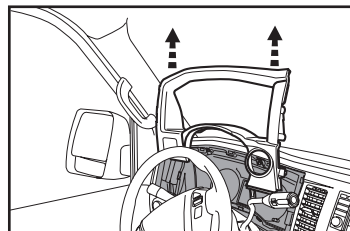

(Figura E)

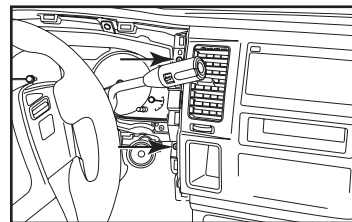

(Figura F)

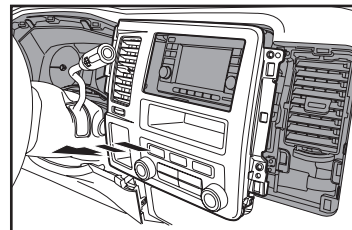

(Figura G)

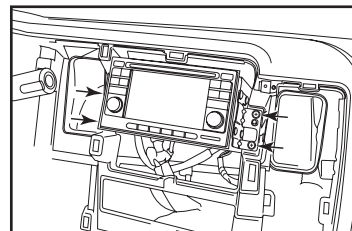

(Figura H)

DESMONTAJE DEL TABLERO

Chevrolet City Express 2015-2018

Nissan NV200 2013-2021

1. Desenganche y quite el botón deslizante de recircular/aire fresco. (Figura A)
2. Desenganche y quite todo el panel de moldura que rodea la pantalla, incluyendo los controles del aire acondicionado. (Figura B)
3. Retire los (4) tornillos Phillips que sostienen el radio. (Figura C)

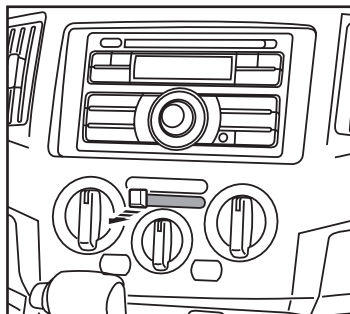

(Figura A)

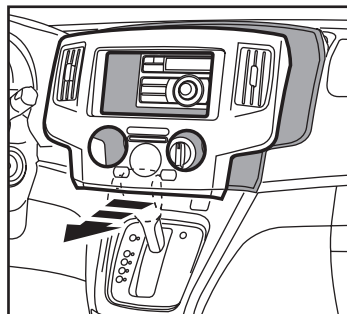

(Figura B)

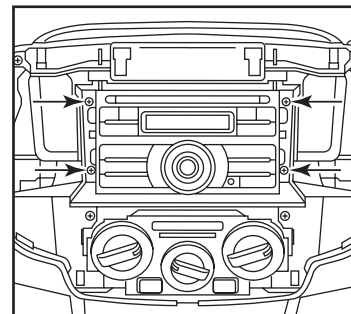

(Figura C)

Continúe con el ensamble del kit

DESMONTAJE DEL TABLERO

Nissan Quest

(sin NAV o entretenimiento para el asiento trasero) 2011-2016

1. Desenganche y quite los paneles de la parte izquierda y derecha de abajo de la consola central. (Figura A)
2. Quite los (2) ganchos de cada lado que quedan a la vista detrás de los paneles de abajo. (Figura B)
3. Desenganche y jale la consola central hacia la parte de atrás del vehículo. **Nota:** No es necesario quitar completamente la consola. (Figura C)

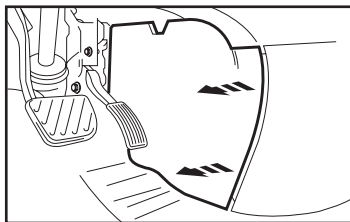

(Figura A)

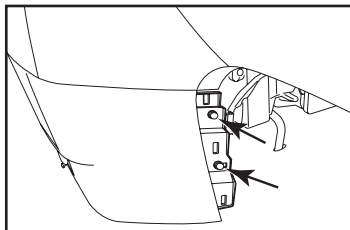

(Figura B)

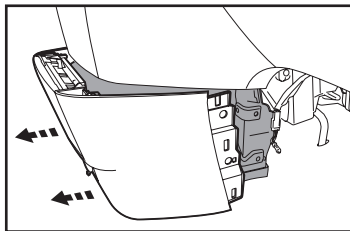

(Figura C)

4. Desenganche y quite el panel de la moldura del lado izquierdo de la palanca de velocidades donde se encuentra el botón de inicio/paro. (Figura D)
5. Desenganche y quite el panel que está al final del lado del pasajero en el tablero. (Figura E)
6. Quite (1) tornillo Phillips del panel de la moldura que está arriba de la guantera, luego desenganche y quite el panel. (Figura F)

Continúa en la siguiente página.

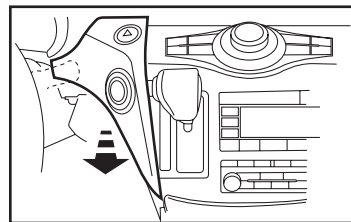

(Figura D)

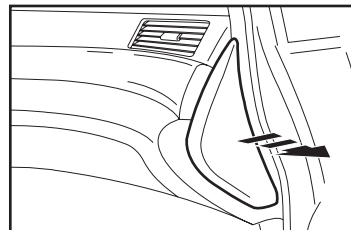

(Figura E)

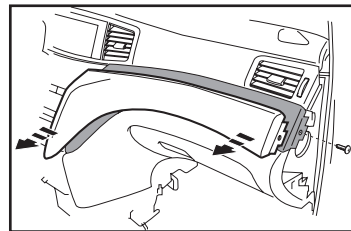

(Figura F)

DESMONTAJE DEL TABLERO (CONT.)

Nissan Quest

(sin NAV o entretenimiento para el asiento trasero) 2011-2016 (Cont)

7. Quite (1) tornillo Phillips del panel de la moldura del portavasos, luego desenganche y quite el panel. (Figura G)
8. Quite los (2) tornillos Phillips del panel de control del aire acondicionado y desenganche y déjelo colgando. (Figura H)
9. Quite los (2) tornillos Phillips de la parte de abajo del panel de la moldura del radio, incluyendo las rejillas, luego desenganche y quite el panel. (Figura H)
10. Retire los (4) tornillos Phillips que sostienen el radio. (Figura I)

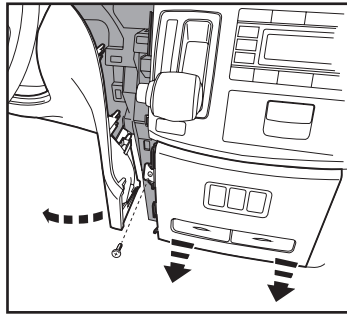

(Figura G)

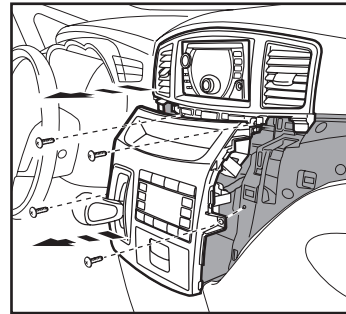

(Figura H)

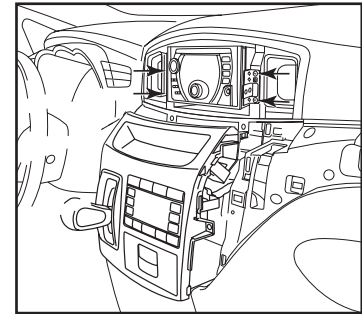

(Figura I)

Continúe con el ensamble del kit

DESMONTAJE DEL TABLERO

Nissan Rogue

(S con paquete de edición especial) 2011-2013

Nissan Rogue SV 2012-2013

Nissan Rogue Select (con pantalla de 4.3")
2014-2015

1. **Si está equipado con bocina central:**
Desenganche y quite la rejilla, luego quite los (4) tornillos Phillips para quitar la bocina. (Figura A)
2. Desenganche y quite el panel de abajo del radio, incluyendo los controles del aire acondicionado. (Figura B)

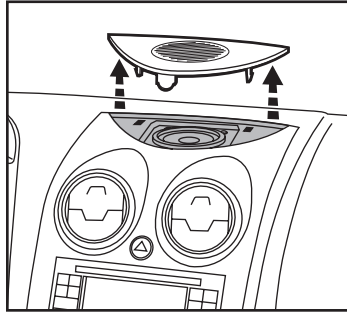

(Figura A)

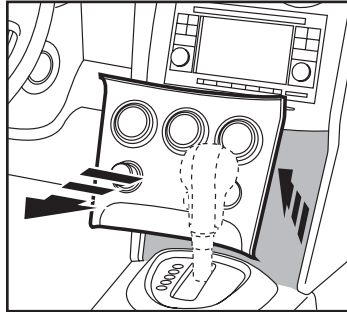

(Figura B)

3. Desenganche la moldura del radio, incluyendo las rejillas del aire acondicionado, luego desconecte el interruptor de las luces intermitentes y quite el panel. (Figura C)
4. Retire los (4) tornillos Phillips que sostienen el radio. (Figura D)

Continúe con el ensamble del kit

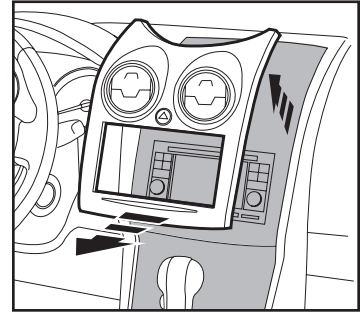

(Figura C)

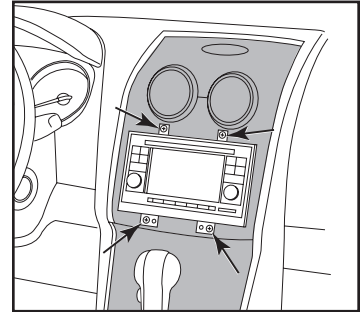

(Figura D)

DESMONTAJE DEL TABLERO

Nissan Titan (todos excepto el ajuste S) 2013-2015

1. Desenganche todo el panel del tablero, incluyendo los controles del clima. Desconecte y quite el panel. (Figura A)
2. Retire los (4) tornillos Phillips que sostienen el radio. Desconecte y quite el chasis. (Figura B)

Continúe con el ensamble del kit

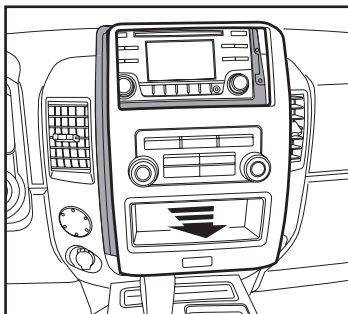

(Figura A)

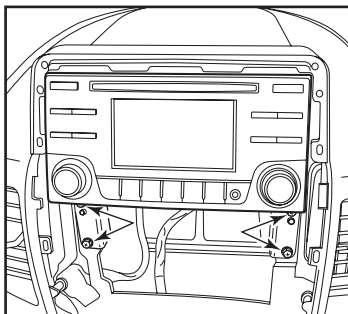

(Figura B)

Nissan Versa 2007-2011

1. Desenganche y quite el panel de arriba del radio. (Figura A, B)
2. Quite los (2) tornillos Phillips que sostienen el panel de la moldura del radio y luego desenganche y quite todo el panel que rodea el radio y los controles del aire acondicionado. (Figura C)
3. Quite los (4) tornillos Phillips que sostienen el radio, desconecte y quite el radio. (Figura D)

Continúe con el ensamble del kit

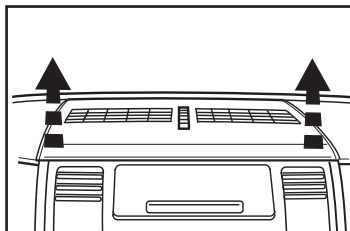

(Figura A)

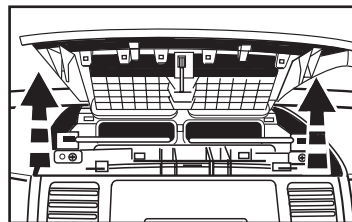

(Figura B)

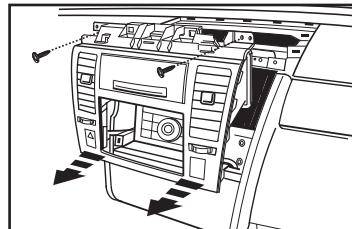

(Figura C)

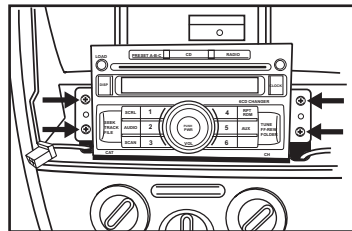

(Figura D)

DESMONTAJE DEL TABLERO

Nissan Versa 2012-2019

Nissan Versa Note 2014-2019

1. Desenganche y quite todo el panel que rodea el radio, incluyendo las rejillas del aire acondicionado. (Figura A)
2. Retire los (4) tornillos Phillips que sostienen el radio. (Figura B)

Continúe con el ensamble del kit

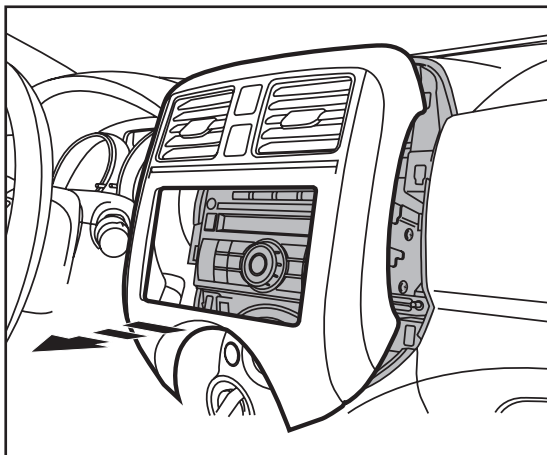

(Figura A)

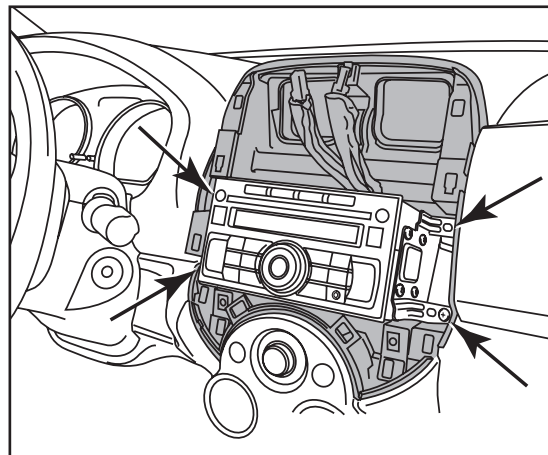

(Figura B)

ENSAMBLE DEL KIT

Uso del panel de recubrimiento de la caja de radio

Vehículo	Panel de moldura
Chevrolet City Express (sin NAV) 2015-2018	Estándar
Chevrolet City Express (con NAV) 2015-2018	Amplio
Nissan Cube 2009-2014	Estándar
Nissan Frontier (con pantalla de 4.3") 2013-2021	Amplio
Nissan Juke 2011-2014	Estándar
Nissan Juke 2015-2017	Amplio
Nissan NV 2012-2021	Estándar
Nissan NV (sin NAV) 2015-2021	Estándar
Nissan NV (con NAV) 2015-2021	Amplio
Nissan NV200 (sin NAV) 2013-2021	Estándar
Nissan NV200 (con NAV) 2013-2021	Amplio
Nissan Quest (sin NAV o entretenimiento para el asiento trasero) 2011-2012	Estándar
Nissan Quest (sin NAV o entretenimiento para el asiento trasero) 2013-2016	Amplio
Nissan Rogue Select (con la radio modelo más baja) 2014-2015	Estándar
Nissan Rogue Select (con radio modelo superior) 2014-2015	Amplio

Vehículo	Panel de moldura
Nissan Rogue S (con paquete de edición especial) 2012-2013	Amplio
Nissan Rogue SV 2012-2013	Amplio
Nissan Rogue S and SV (con paquete SL) 2003-2007	Estándar
Nissan Rogue 2011	Estándar
Nissan Titan (todos excepto el ajuste S) 2013-2015	Amplio
Nissan Versa 2007-2011	Estándar
Nissan Versa 2012-2013	Estándar

Vehículo	Panel de moldura
Nissan Versa S, S+ and SV (sin opciones) 2014-2019	Estándar
Nissan Versa Note 2014-2019	Amplio
Nissan Versa SL and SV (con paquete de conveniencia) 2014-2019	Amplio
Nissan Versa and Versa Note (todos los modelos) 2015-2019	Amplio
Nissan Xterra (con pantalla de 4.3") 2013	Amplio

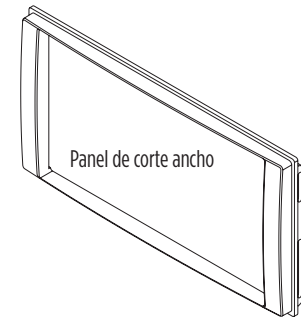
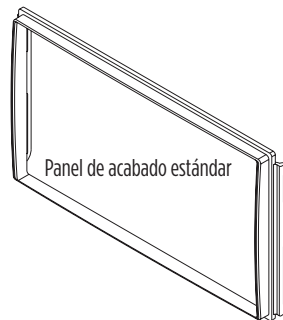

ENSAMBLE DEL KIT

Disposición de la pestaña del soporte #1

Soporte #	# Pestaña	Vehículo	
1	A	Versa	2012-2019
1	A	Versa Note	2014-2019
1	B	Rogue	2011-2013
1	B	Rogue Select	2014-2015
1	C	NV	2012-2021
1	C	Quest (sin NAV o entretenimiento para el asiento trasero)	2011-2016

Nota: Puede ser necesario retirar todas las pestañas no necesarias de los soportes para ciertas aplicaciones. Dependiendo de la aplicación, también puede ser necesario cortar todo el soporte tan cerca como sea posible a los sitios de montaje del radio en los soportes.

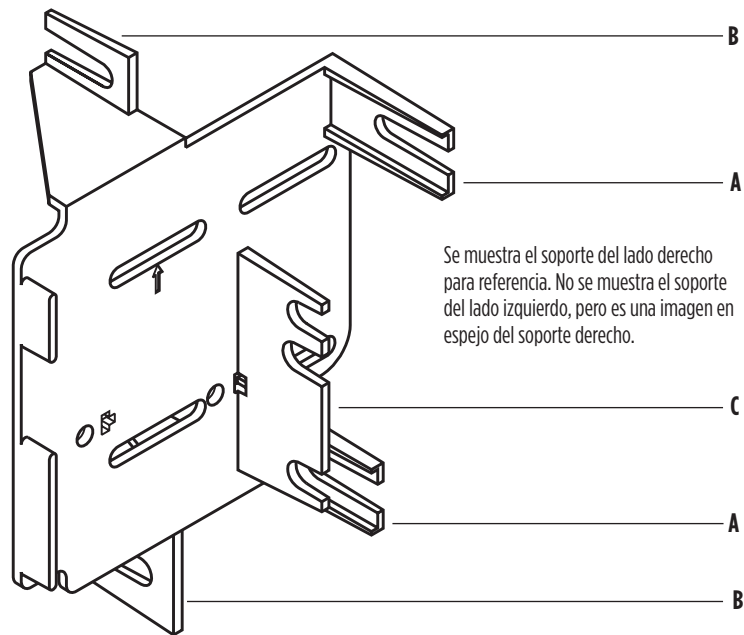

ENSAMBLE DEL KIT

Disposición de la pestaña del soporte #2

Soporte #	Pestaña #	Vehículo
2	E	Chevrolet City Express 2015-2018
2	D	Nissan Juke 2011-2017
2	E	Nissan NV200 2013-2021
2	E	Nissan Cube (use espaciadores) 2009-2014

Nota: Puede ser necesario retirar todas las pestañas no necesarias de los soportes para ciertas aplicaciones. Dependiendo de la aplicación, también puede ser necesario cortar todo el soporte tan cerca como sea posible a los sitios de montaje del radio en los soportes.

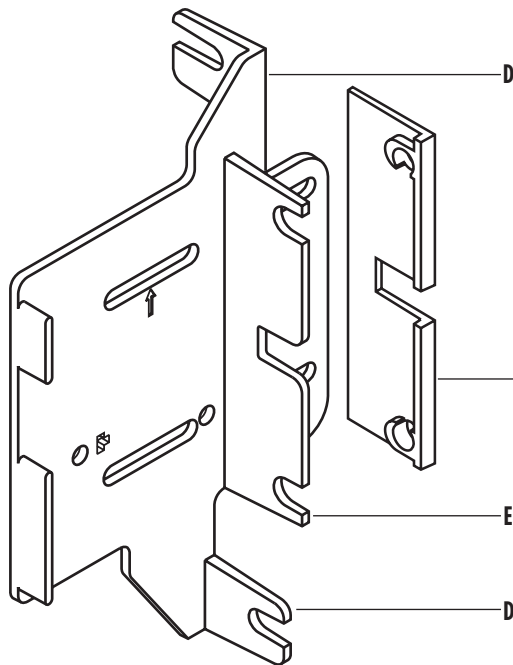

Se muestra el soporte del lado derecho para referencia. No se muestra el soporte del lado izquierdo, pero es una imagen en espejo del soporte derecho.

Espaciador para Nissan Cube, úselo con el juego de soportes 2, pestaña E

ENSAMBLE DEL KIT

Provisión de radio ISO DDIN

1. Una el **soporte** correspondiente al **panel de la moldura de la carcasa del radio**. (Se muestra el soporte #2 con el panel de la moldura del radio estándar) (Figura A)
2. Deslice el radio en el conjunto del soporte y sujételo con los tornillos suministrados con el radio. (Figura B)
3. Ubique el arnés de cableado de fábrica y el conector de la antena en el tablero. Metra recomienda el uso de los adaptadores adecuados de acoplamiento de Metra y/o AXCESS.
4. Monte el conjunto del radio en el tablero y vuelva a armar el tablero al revés de como lo desarmó.

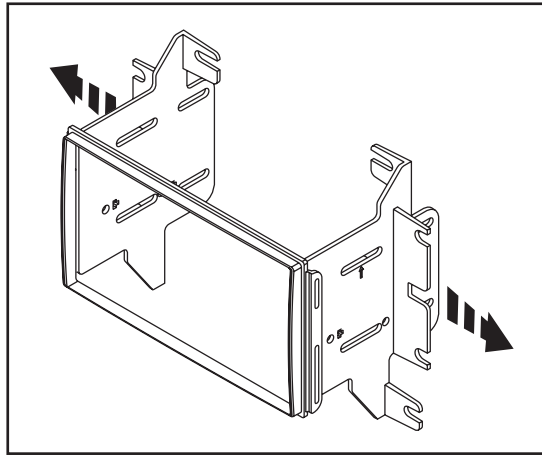

(Figura A)

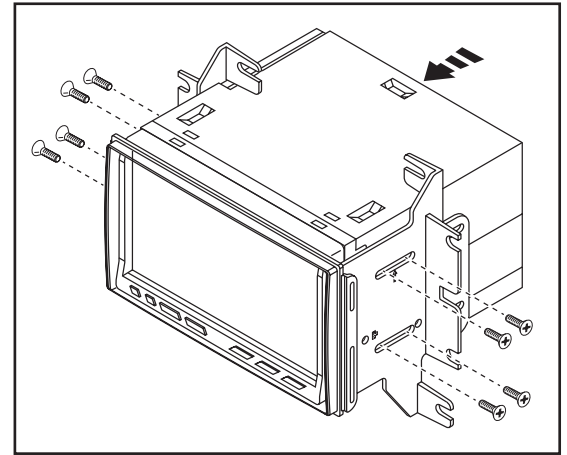

(Figura B)



95-7624
INSTRUCCIONES DE INSTALACIÓN



¿Tienes dificultades? Estamos aquí para ayudar.



Póngase en contacto con nuestra
línea de soporte técnico en:
386-257-1187



O por correo electrónico a:
techsupport@metra-autosound.com

Horas de soporte técnico (hora estándar del este)

Monday - Friday: 9:00 AM - 7:00 PM

Saturday: 10:00 AM - 7:00 PM

Sunday: 10:00 AM - 4:00 PM



KNOWLEDGE IS POWER

Enhance your installation and fabrication skills by enrolling in the most recognized and respected mobile electronics school in our industry. Log onto www.installerinstitute.edu or call 386-672-5771 for more information and take steps toward a better tomorrow.



**Metra recomienda MECP
técnicos certificados**