



### Subaru **Legacy, Outback** (all) **2015-2017** **Legacy, Outback** (base models\*) **2018-2019**

\*Use **95-8906** for base models with no options and the 6.5" factory radio screen

**Note:** Use **95-8909** for all models with 8" factory radio screen

Visit [MetraOnline.com](http://MetraOnline.com) for more detailed information about the product and up-to-date vehicle specific applications

#### KIT FEATURES

- Double DIN radio provision
- Painted high gloss black to match the factory finish

#### KIT COMPONENTS

- A) Radio housing trim panel • B) Radio brackets

A

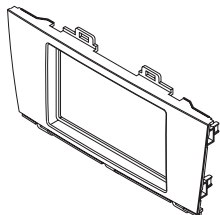

B

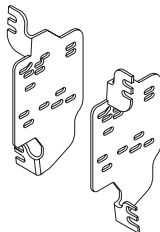

#### TABLE OF CONTENTS

Dash Disassembly .....	2
Kit Assembly	
Double DIN radio provision .....	3

#### WIRING & ANTENNA CONNECTIONS (sold separately)

Please visit [AxcessInterfaces.com](http://AxcessInterfaces.com)  
for audio/video and steering wheel  
control interface options

Antenna Adapter: 40-LX11

#### TOOLS REQUIRED

- Panel removal tool • Phillips screwdriver

**ATTENTION:** With the key out of the ignition, disconnect the negative battery terminal before installing this product. Ensure that all installation connections, especially the air bag indicator lights, are plugged in before reconnecting the battery or cycling the ignition to test this product.

**NOTE:** Refer also to the instructions included with the aftermarket accessory before installing this device.

## DASH DISASSEMBLY

1. Unclip and remove the trim panel from around the climate controls. (Figure A)
2. Remove (2) Phillips screws securing the climate controls then unclip and remove them. (Figure B)
3. Unclip and remove the a/c vents above the factory radio. (Figure C)
4. Remove (4) Phillips screws securing the radio then unclip and remove the radio. (Figure D)
5. Unclip the four plastic panel clips from the factory radio and place them onto the 95-8906 radio trim panel.

*Continue to Kit Assembly*

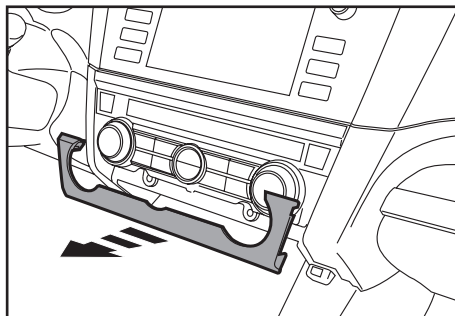

(Figure A)

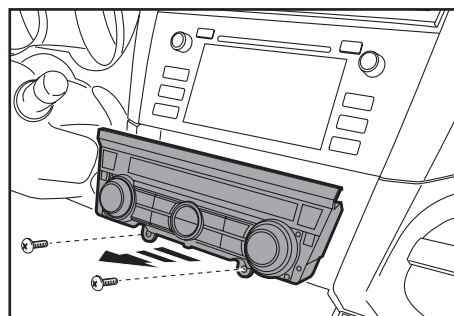

(Figure B)

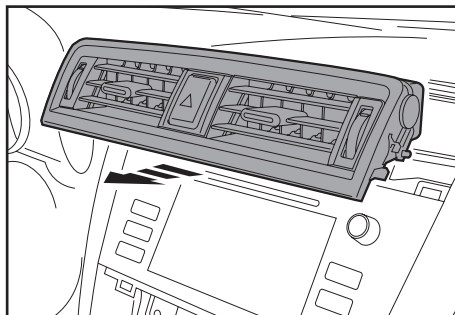

(Figure C)

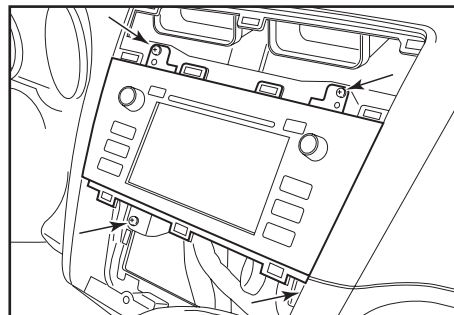

(Figure D)

## KIT ASSEMBLY

### Double DIN radio provision

1. Attach the brackets to the radio with the screws included with radio. (Figure A)
2. Locate the factory wiring harness and antenna plug in the dash and make all necessary wire connections to the radio. Metra recommends using the proper mating adapters from Metra and/or AXXESS.
3. Mount the new radio assembly into the dash.
4. Attach the (4) factory panel clips to the **95-8906HG** radio trim panel.
5. Reassemble the dash in the reverse order of disassembly using the **95-8906HG** radio trim panel.

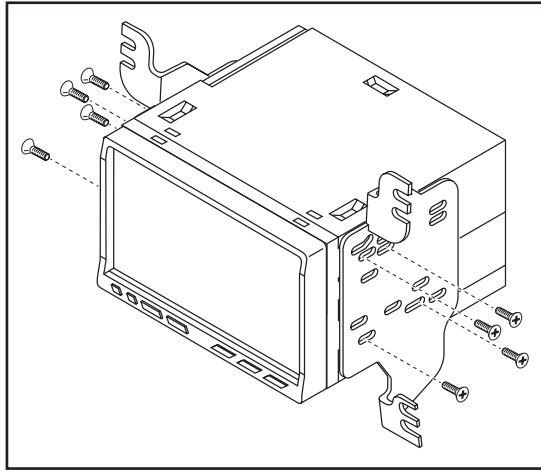

(Figure A)



**95-8906HG**  
INSTALLATION INSTRUCTIONS



Having difficulties? We're here to help.



Contact our Tech Support line at:

**386-257-1187**



Or via email at:

[techsupport@metra-autosound.com](mailto:techsupport@metra-autosound.com)

**Tech Support Hours (Eastern Standard Time)**

Monday - Friday: 9:00 AM - 7:00 PM

Saturday: 10:00 AM - 5:00 PM

Sunday: 10:00 AM - 4:00 PM



**Metra recommends MECP  
certified technicians**