



Volkswagen Multi-kit 2005-Up

Visit MetraOnline.com for more detailed information about the product and up-to-date vehicle specific applications

KIT FEATURES

- ISO DDIN radio provision
- 95-9011B - Scratch resistant matte black
- 95-9011HG - Painted high gloss black

KIT COMPONENTS

- A) Radio housing • B) ISO DDIN radio brackets • C) DDIN trim plate

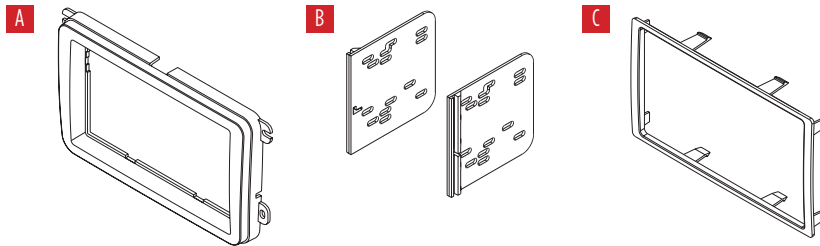

Applications

Beetle	2012-2019	Jetta SportWagen.....	
CC	2009-2017	2010-2014	
EOS	2007-2016		
GTI	2006-2014	Passat	2006-up
Golf, Golf R	2010-2014	R32	2007-2008
Jetta	2005-2018	Rabbit	2007-2009
Jetta GLI	2006-2018	Tiguan	2009-2017

WIRING & ANTENNA CONNECTIONS (sold separately)

Wiring Harness: Visit metraonline.com for wiring harness options

Antenna Adapter: Visit metraonline.com for antenna adapter options

TOOLS REQUIRED

- Panel removal tool • Phillips screwdriver
- Socket wrench

Attention! Let the vehicle sit with the key out of the ignition for a few minutes before removing the factory radio. When testing the aftermarket equipment, ensure that all factory equipment is connected before cycling the key to ignition.

TABLE OF CONTENTS

Dash Disassembly

- Jetta GLI 2006-2018	2-3
- GTI 2006-2009	2-3
- New Jetta 2005-2010	2-3
- Rabbit 2007-2009	2-3
- R32 2007-2008	2-3
- Jetta 2011-2018	3
- CC 2009-2017	3
- Passat 2006-2010	3
- Passat 2012-up	3
- Jetta SportWagen 2010-2014	3
- Jetta GLI 2012-up	3
- Golf, Golf R 2010-2014	3
- GTI 2010-up	3
- Tiguan 2009-2017	4
- EOS 2007-2016	4
- Beetle 2012-2019	5

Kit Assembly	6
--------------------	---

DASH DISASSEMBLY

New Jetta 2005-2010, Jetta GLI 2006-2018, GTI 2006-2009 Rabbit 2007-2009, R32 2007-2008

1. Unclip and remove the grille from the top-center of dash. (Figure A)
2. Remove one T-20 Torx screw from black insert from under grille removed in step one. (Figure B)
3. Remove insert. (Figure C)
4. Remove two T-20 Torx screws from under black insert removed in step two. (Figure D)

Continued on next page

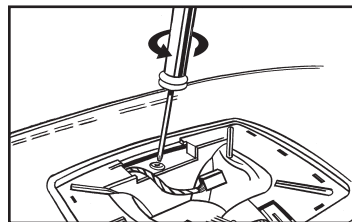

(Figure B)

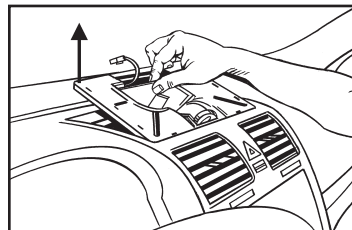

(Figure C)

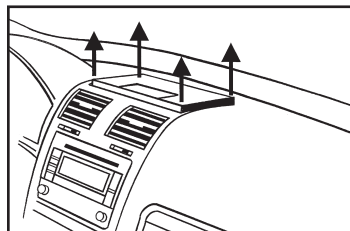

(Figure A)

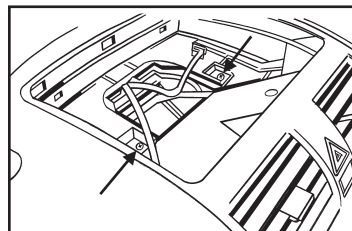

(Figure D)

DASH DISASSEMBLY (CONT.)

- Unclip and remove the grille from the top-center of dash. (Figure E)
- Remove one T-20 Torx screw from black insert from under grille removed in step one. (Figure F)
- Remove insert. (Figure G)
- Remove two T-20 Torx screws from under black insert removed in step two. (Figure H)

Continue to Kit Assembly

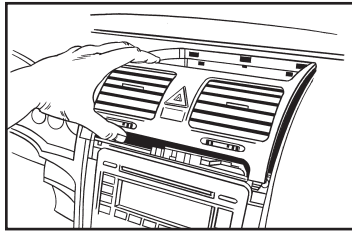

(Figure E)

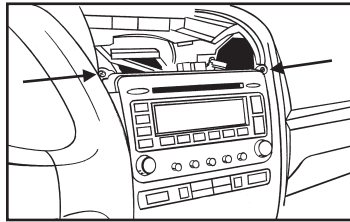

(Figure F)

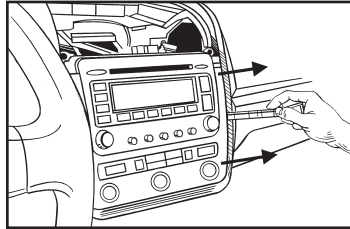

(Figure G)

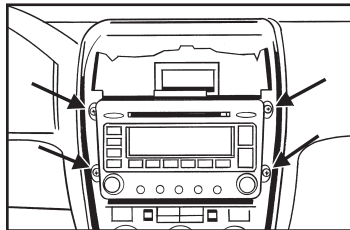

(Figure H)

CC 2009-2017, Passat 2006-2010, Jetta SportWagen 2010-2014, Jetta 2011-2018, Golf, Golf R 2010-2014, GTI 2010-up

- Unclip and remove trim panel surrounding radio. (Figure A)
- Remove (4) T-20 Torx screws to remove radio.

Continue to Kit Assembly

Jetta GLI 2012-up

- Unclip and remove trim panel surrounding radio. (Figure B)
- Remove (4) T-20 Torx screws to remove radio.

Continue to Kit Assembly

Passat 2012-up

- Unclip and remove trim panel surrounding radio. (Figure C)
- Remove (4) T-20 Torx screws to remove radio.

Continue to Kit Assembly

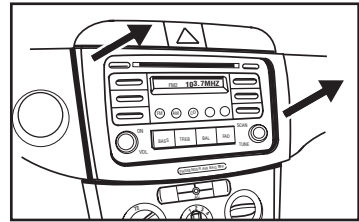

(Figure F)

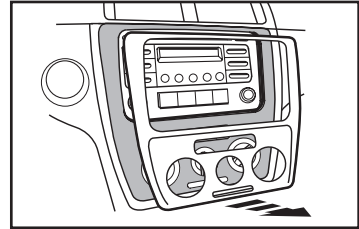

(Figure B)

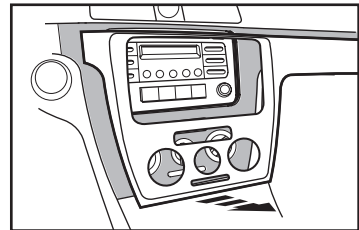

(Figure H)

DASH DISASSEMBLY

Tiguan 2009-2017

1. Unclip and remove passenger air bag light panel to the right of the hazard light button. (Figure A)
2. Unclip and remove the panel with the two slots in it to the left of the hazard light button. (Figure A)
3. Remove (2) T-20 Torx screws exposed behind the two panels removed in the two previous steps. (Figure B)
4. Unclip and remove the trim panel surrounding the radio. (Figure C)
5. Remove (4) T-20 Torx screws securing the radio. Unplug and remove the radio. (Figure D)

Continue to Kit Assembly

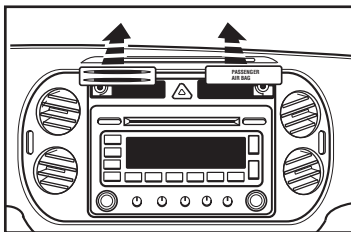

(Figure A)

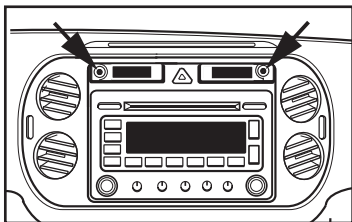

(Figure B)

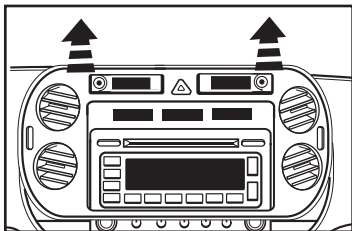

(Figure C)

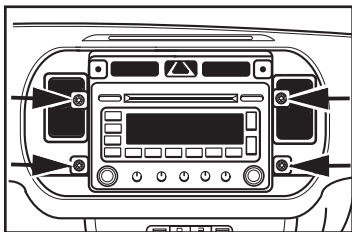

(Figure D)

EOS 2007-2016

1. Unclip and remove the radio trim panel. (Figure A)
2. Remove the (4) screws securing the radio. Unplug and remove the radio. (Figure B)

Continue to Kit Assembly

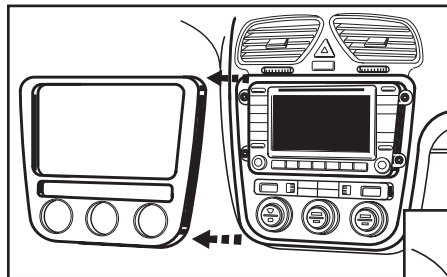

(Figure A)

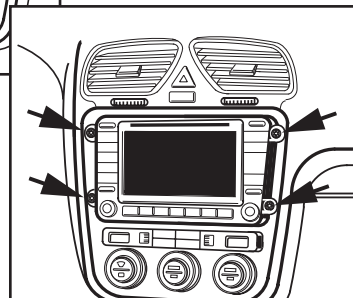

(Figure B)

DASH DISASSEMBLY

Beetle 2012-2019

1. Unclip and remove the small trim around radio. (Figure A)
2. Unclip and remove larger trim around radio including the a/c vents. (Figure B)
3. Remove (4) Torx screws securing radio to remove the radio. (Figure C)

Continue to Kit Assembly

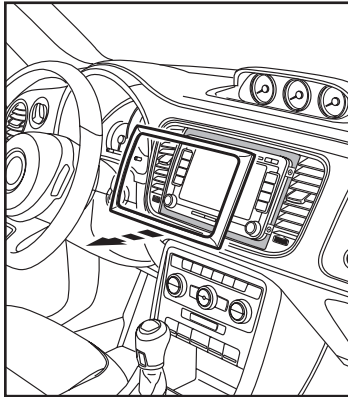

(Figure A)

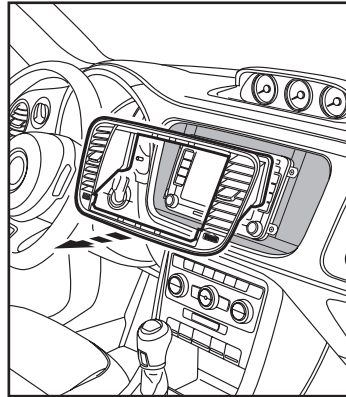

(Figure B)

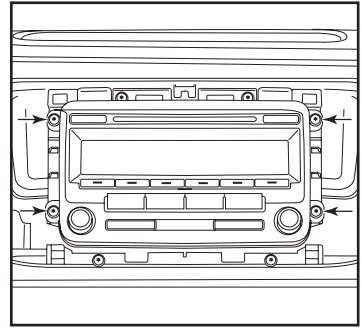

(Figure C)

KIT ASSEMBLY

1. Snap the **ISO DDIN brackets** to the inside edge of the **radio housing**. (Figure A)
2. Slide the DDIN radio into the DDIN bracket/radio housing assembly and secure the radio to the kit using the screws supplied with the radio. (Figure B)
3. Snap the **DDIN trim plate** onto the housing/radio assembly. (Figure B)
4. Locate the factory wiring harness in the dash. Metra recommends using the proper mating adapter from Metra or AXXESS. Test the radio for proper operation.
5. Reassemble dash in reverse order of disassembly.

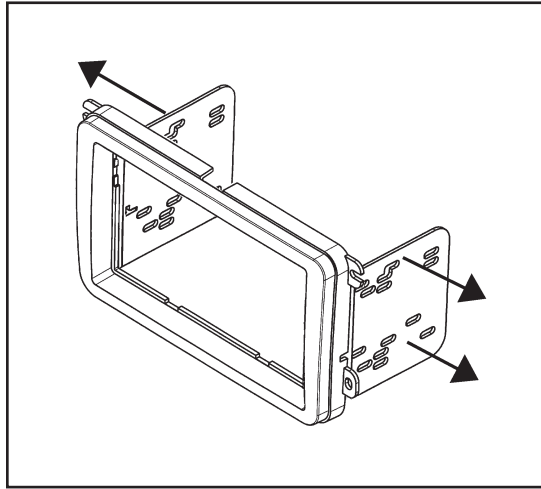

(Figure A)

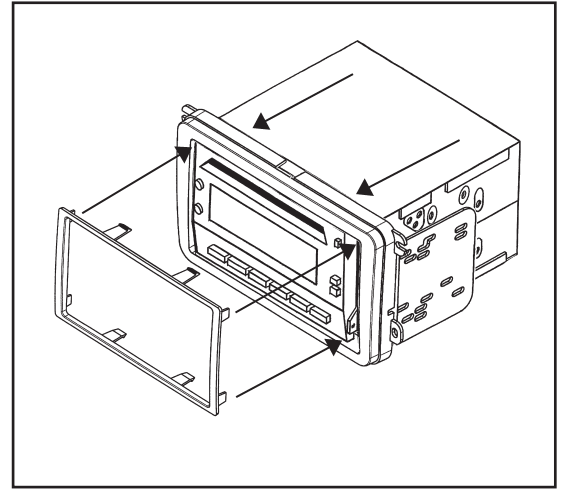

(Figure B)



95-9011
INSTALLATION INSTRUCTIONS



If you are having difficulties with the installation of this product, contact our Tech Support line either by phone at **386-257-1186 ext. 8300**, or email at **techsupport@metra-autosound.com**. Before doing so, look over the instruction booklet a second time and ensure that the installation was performed exactly as the instruction booklet is stated. Have the vehicle apart and ready to perform troubleshooting steps before contacting Metra/Axxess Tech Support.



KNOWLEDGE IS POWER

Enhance your installation and fabrication skills by enrolling in the most recognized and respected mobile electronics school in our industry. Log onto www.installerinstitute.com or call 800-354-6782 for more information and take steps toward a better tomorrow.



Metra recommends MECP certified technicians



Volkswagen Multi-kit 2005 y mas

Visite MetraOnline.com para obtener información más detallada sobre el producto y aplicaciones actualizadas específicas para vehículos.

CARACTERÍSTICAS DEL KIT

- Provisión de radio doble ISO DIN
- 95-9011B - Negro mate resistente a los arañazos
- 95-9011HG - Pintado negro brillante

COMPONENTES DEL KIT

- A) Carcasa del radio • B) Soportes ISO DDIN • C) Placa de moldura DDIN

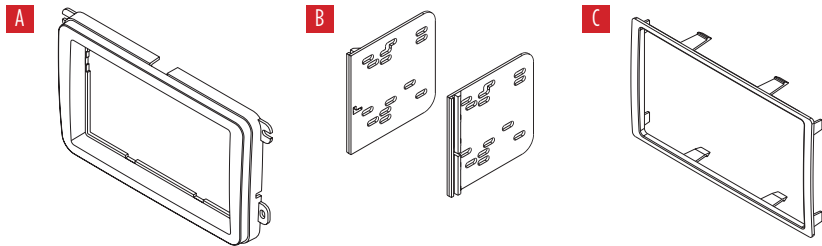

APLICACIONES

Beetle	2012-2019	Jetta SportWagen.....	
CC	2009-2017	2010-2014	
EOS	2007-2016		
GTI	2006-2014	Passat	2006 y mas
Golf, Golf R	2010-2014	R32	2007-2008
Jetta	2005-2018	Rabbit	2007-2009
Jetta GLI	2006-2018	Tiguan	2009-2017

CABLEADO Y CONEXIONES DE ANTENA

(se venden por separado)

Arnés de cableado: visite metraonline.com para ver las opciones de cableado

Adaptador de antena: visite metraonline.com para conocer las opciones de adaptador de antena

HERRAMIENTAS REQUERIDAS

- Herramienta para quitar paneles
- Destornillador Phillips • Llave del tubo

¡PRECAUCIÓN! Todos los accesorios, interruptores, paneles de controles de clima y especialmente las luces del indicador de las bolsas de aire deben estar conectados antes ciclar la ignición. Además, no quite el radio de fábrica con la llave en la posición de encendido ni con el vehículo funcionando.

Desmontaje del tablero

- Jetta GLI 2006-2018	2-3
- GTI 2006-2009	2-3
- New Jetta 2005-2010.....	2-3
- Rabbit 2007-2009.....	2-3
- R32 2007-2008.....	2-3
- Jetta 2011-2018.....	3
- CC 2009-2017.....	3
- Passat 2006-2010.....	3
- Passat 2012-up.....	3
- Jetta SportWagen 2010-2014.....	3
- Jetta GLI 2012-up.....	3
- Golf, Golf R 2010-2014.....	3
- GTI 2010 y mas.....	3
- Tiguan 2009-2017.....	4
- EOS 2007-2016.....	4
- Beetle 2012-2019.....	5

Ensamble del kit	6
-------------------------------	---

New Jetta 2005-2010, Jetta GLI 2006-2018, GTI 2006-2009 Rabbit 2007-2009, R32 2007-2008

1. Desenganche y quite la rejilla del centro superior del tablero. (Figura A)
2. Quite el tornillo Torx T-20 del inserto negro debajo de la rejilla que quitó en el paso uno. (Figura B)
3. Quite el inserto. (Figura C)
4. Quite los dos tornillos Torx T-20 de abajo del inserto negro que quitó en el paso dos. (Figura D)

Continúa en la siguiente página

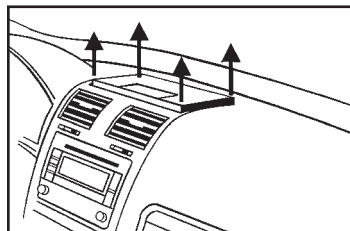

(Figura A)

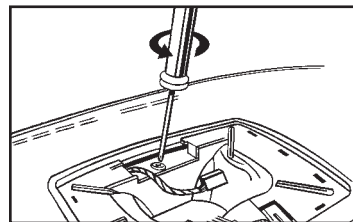

(Figura B)

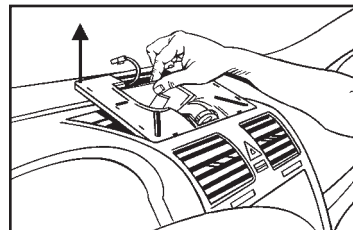

(Figura C)

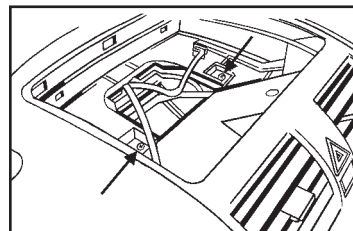

(Figura D)

DESMONTAJE DEL TABLERO (CONT.)

- Desenganche y quite la rejilla del centro superior del tablero. (Figura E)
- Quite el tornillo Torx T-20 del inserto negro debajo de la rejilla que quitó en el paso uno. (Figura F)
- Quite el inserto. (Figura G)
- Quite los dos tornillos Torx T-20 de abajo del inserto negro que quitó en el paso dos. (Figura H)

Continúe con el ensamble del kit

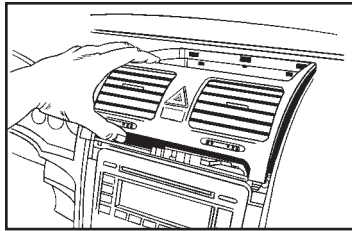

(Figura E)

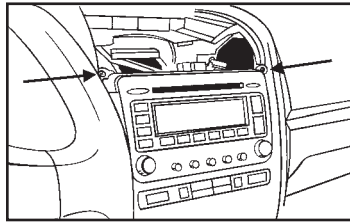

(Figura F)

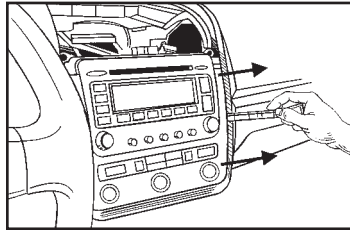

(Figura G)

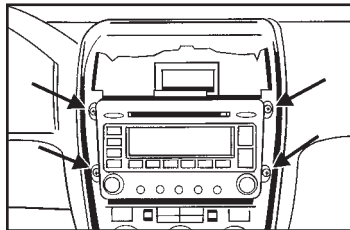

(Figura H)

CC 2009-2017, Passat 2006-2010, Jetta SportWagen 2010-2014, Jetta 2011-2018, Golf, Golf R 2010-2014, GTI 2010 y mas

- Desenganche y quite el panel de la moldura que rodea el radio. (Figura A)
- Quite los (4) tornillos Torx T-20 para quitar el radio.

Continúe con el ensamble del kit

Jetta GLI 2012y mas

- Desenganche y quite el panel de la moldura que rodea el radio. (Figura A)
- Quite los (4) tornillos Torx T-20 para quitar el radio.

Continúe con el ensamble del kit

Passat 2012 y mas

- Desenganche y quite el panel de la moldura que rodea el radio. (Figura A)
- Quite los (4) tornillos Torx T-20 para quitar el radio.

Continúe con el ensamble del kit

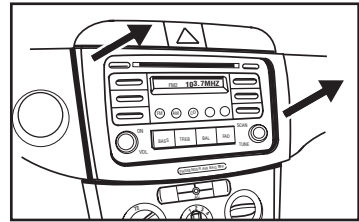

(Figura F)

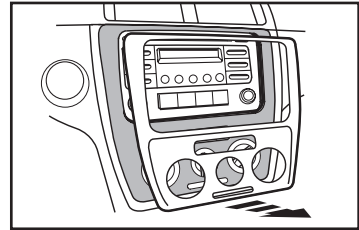

(Figura G)

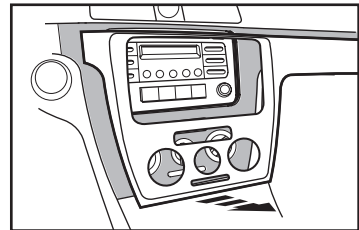

(Figura H)

DESMONTAJE DEL TABLERO

Tiguan 2009-2017

1. Desenganche y quite el panel del foco de la bolsa de aire del pasajero a la derecha del botón de las luces intermitentes. (Figura A)
2. Desenganche y quite el panel que tiene dos ranuras a la izquierda del botón de las luces intermitentes. (Figura A)
3. Quite los (2) tornillos Torx T-20 expuestos detrás de los dos paneles que quitó en los dos pasos anteriores. (Figura B)
4. Desenganche y quite el panel de moldura que rodea el radio. (Figura C)
5. Quite los (4) tornillos Torx T-20 que sujetan el radio. Desconecte y quite el radio. (Figura D)

Continúe con el ensamble del kit

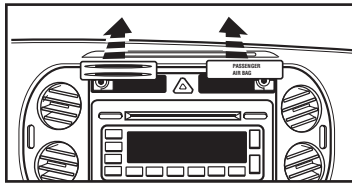

(Figura A)

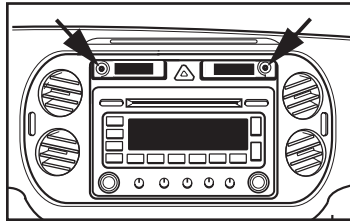

(Figura B)

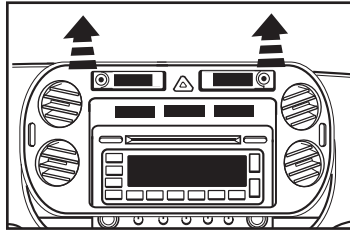

(Figura C)

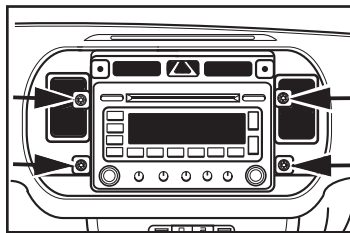

(Figura D)

EOS 2007-2016

1. Desenganche y quite el panel de la moldura del radio. (Figura A)
2. Quite los (4) tornillos que sujetan el radio. Desconecte y quite el radio. (Figura B)

Continúe con el ensamble del kit

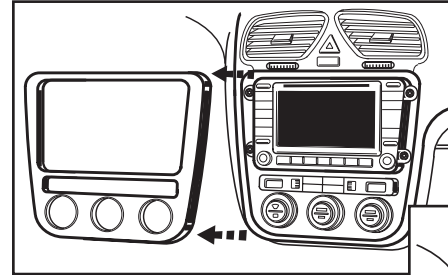

(Figura A)

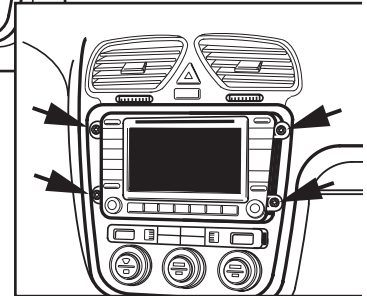

(Figura B)

DESMONTAJE DEL TABLERO

Beetle 2012-2019

1. Desenganche y quite la pequeña moldura que rodea el radio. (Figura A)
2. Desenganche y quite la moldura más grande que rodea el radio, incluyendo las rejillas del aire acondicionado. (Figura B)
3. Quite los (4) tornillos Torx que sujetan el radio para quitarlo. (Figura C)

Continúe con el ensamble del kit

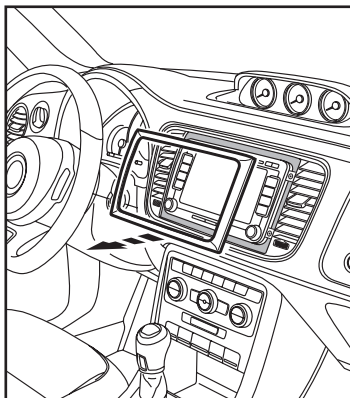

(Figura A)

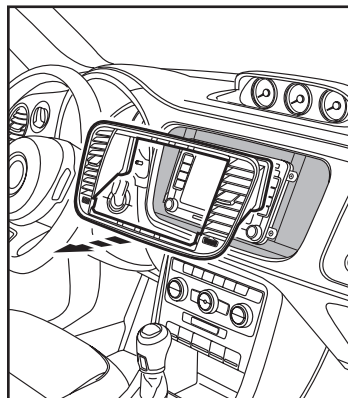

(Figura B)

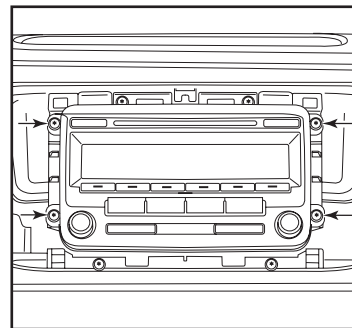

(Figura C)

ENSAMBLE DEL KIT

1. Coloque a presión **los soportes ISO DDIN** en el borde interior de la **carcasa del radio**. (Figura A)
2. Deslice el radio DDIN en el soporte/ensamble de carcasa del radio DDIN y sujete el radio al kit utilizando los tornillos suministrados con el radio. (Figura B)
3. Coloque a presión la **placa de la moldura DDIN** en la carcasa/conjunto del radio. (Figura B)
4. Ubique el arnés de cableado de fábrica en el tablero. Metra recomienda el uso de un adaptador adecuado de acoplamiento de Metra o de AXCESS. Probar la radio para su correcto funcionamiento.
5. Vuelva a armar el tablero al revés de como lo desarmó.

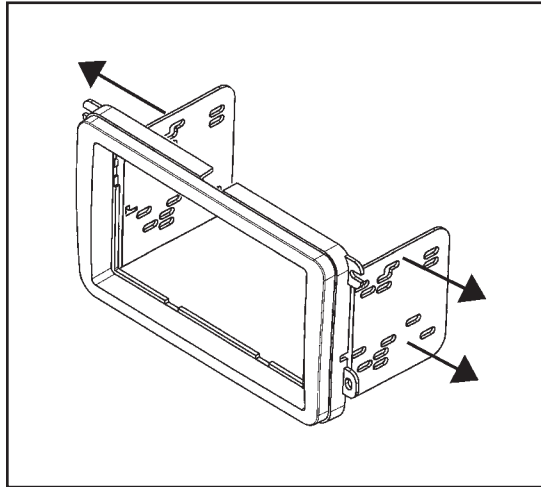

(Figura A)

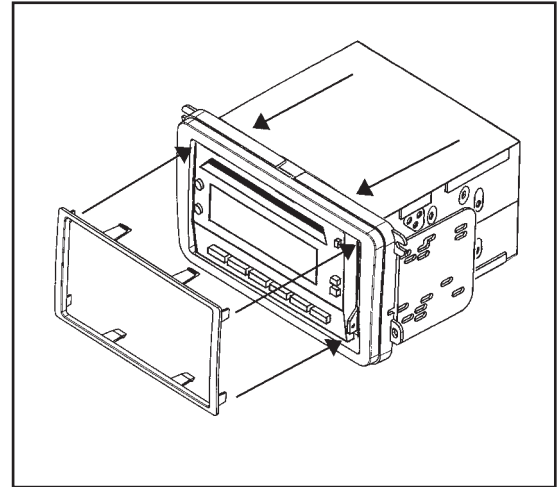

(Figura B)





95-9011

INSTRUCCIONES DE INSTALACIÓN



Si tiene dificultades con la instalación de este producto, comuníquese con nuestra línea de soporte técnico, ya sea por teléfono al **386-257-1187**, o envíe un correo electrónico a **techsupport@metra-autosound.com**. Antes de hacerlo, revise el folleto de instrucciones por segunda vez y asegúrese de que la instalación se realizó exactamente como se indica en el manual de instrucciones. Tenga el vehículo separado y listo para realizar los pasos de solución de problemas antes de ponerse en contacto con el soporte técnico de Metra / Axxess.



EL CONOCIMIENTO ES PODER

Mejore sus habilidades de instalación y fabricación inscribiéndose en la escuela de dispositivos electrónicos móviles más reconocida y respetada de nuestra industria. Regístrese en www.installerinstitute.com o llame al 800-354-6782 para obtener más información y avance hacia un futuro mejor.



**Metra recomienda MECP
Técnicos certificados**