



## Dodge Sprinter 2007-2009 / Freightliner Sprinter 2007-2018 / Mercedes Metris 2016-Up / Sprinter 2010-2018

Visit [MetraOnline.com](http://MetraOnline.com) for more detailed information about the product and up-to-date vehicle specific applications

### KIT FEATURES

- DIN radio provision with pocket
- ISO DIN radio provision with pocket
- ISO DDIN radio provision

### KIT COMPONENTS

- A) Radio housing • B) ISO DIN radio brackets • C) ISO Trim plate • D) ISO DDIN radio brackets • E) ISO DDIN trim plate • F) Pocket

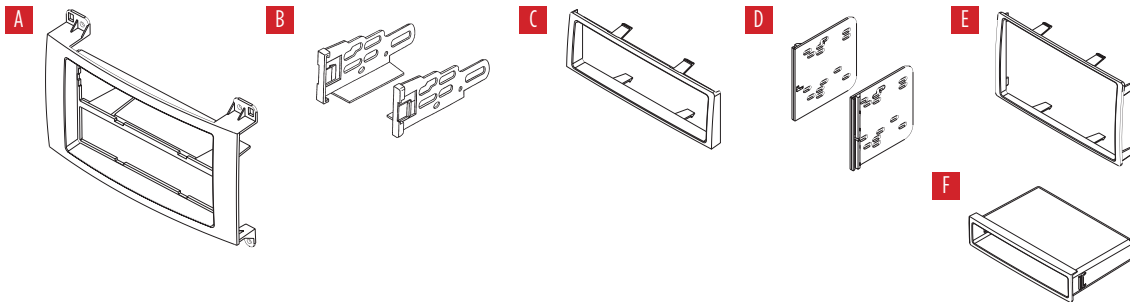

### TABLE OF CONTENTS

Dash Disassembly .....	2
Kit Assembly	
–DIN radio provision with pocket .....	2
–ISO DIN radio provision with pocket .....	3
–ISO DDIN radio provision.....	3

### WIRING & ANTENNA CONNECTIONS (sold separately)

Wiring Harness: Please visit [metraonline.com](http://metraonline.com) for wiring harness options

Antenna Adapter: Please visit [metraonline.com](http://metraonline.com) for antenna adapter options

### TOOLS REQUIRED

- Panel removal tool • Phillips screwdriver
- Torx screwdriver

**Attention!** Let the vehicle sit with the key out of the ignition for a few minutes before removing the factory radio. When testing the aftermarket equipment, ensure that all factory equipment is connected before cycling the key to ignition.

## DASH DISASSEMBLY

1. Unclip the trim panel surrounding the climate controls and radio including the hazard switch panel. Unplug and remove the panel. (Figure A)
2. Unclip and remove pocket if so equipped. (Figure B)
3. Remove (4) T-20 Torx screws securing the radio. Unplug and remove radio. (Figure C)

Continue to Kit Assembly

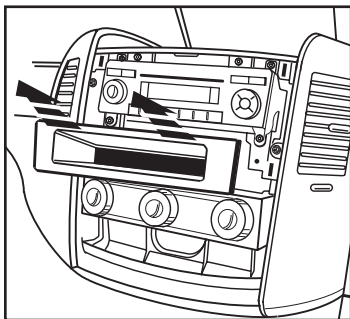

(Figure B)

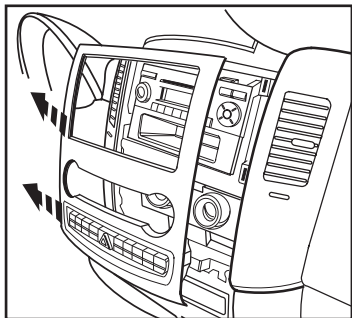

(Figure A)

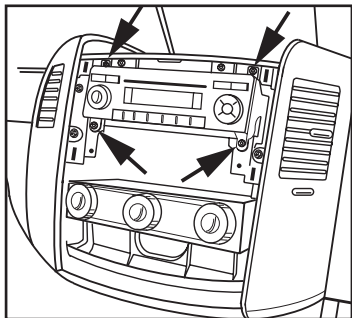

(Figure C)

## KIT ASSEMBLY

### DIN radio provision with pocket

1. Slide the DIN sleeve into the **radio housing** and secure by bending the metal locking outward. (Figure A)
2. Slide the aftermarket radio into the sleeve until it snaps into place. (Figure B)
3. Snap the **pocket** into the **radio housing**. (Figure C)
4. Locate the factory wiring harness and antenna plug in the dash. Metra recommends using the proper mating adapters from Metra and/or AXXESS. Test the radio for proper operation.
5. Reassemble the dash in the reverse order of disassembly

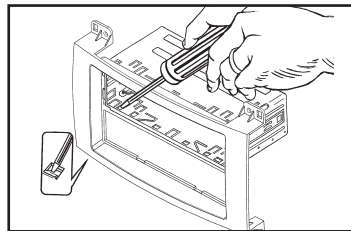

(Figure A)

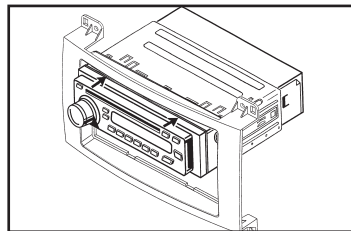

(Figure B)

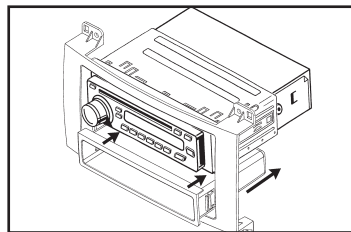

(Figure C)

# KIT ASSEMBLY

## ISO DIN radio provision with pocket

1. Secure the **ISO radio brackets** to the radio using the screws supplied with the radio. (Figure A)
2. Slide the radio/bracket assembly into the **radio housing** until it snaps into place. (Figure B)
3. Snap the **ISO trim plate** onto the front of the **radio housing**. (Figure B)
4. Snap the **pocket** into the **radio housing**. (Figure C)
5. Locate the factory wiring harness and antenna plug in the dash. Metra recommends using the proper mating adapters from Metra and/or AXXESS. Test the radio for proper operation.
6. Reassemble the dash in the reverse order of disassembly

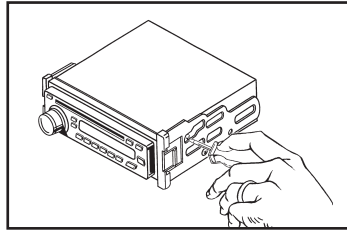

(Figure A)

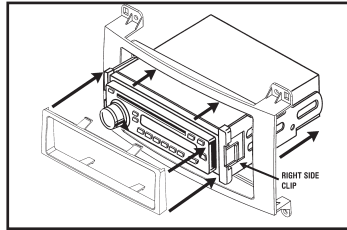

(Figure B)

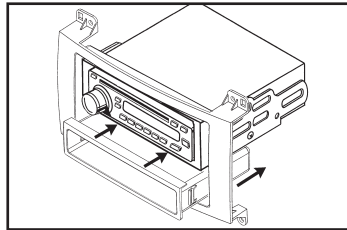

(Figure C)

## ISO DDIN radio provision

1. Cut and remove the center bar from the **radio housing**. (Figure A)
2. Snap the **ISO DDIN brackets** to the inside edge of the **radio housing**. (Figure B)
3. Slide the aftermarket radio into the bracket/radio housing assembly and secure the radio using the screws supplied with the radio. (Figure C)
4. Snap the **ISO DDIN trim plate** onto the front of the radio/housing assembly. (Figure C)
5. Locate the factory wiring harness and antenna plug in the dash. Metra recommends using the proper mating adapters from Metra and/or AXXESS. Test the radio for proper operation.
6. Reassemble the dash in the reverse order of disassembly

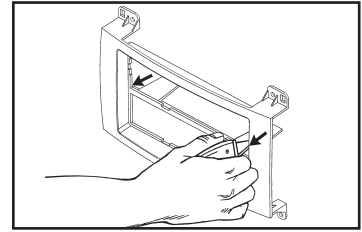

(Figure A)

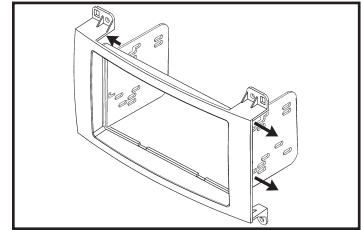

(Figure B)

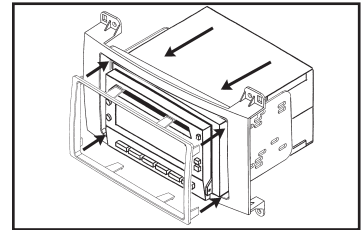

(Figure C)



**99-6512**  
INSTALLATION INSTRUCTIONS



If you are having difficulties with the installation of this product, contact our Tech Support line either by phone at **386-257-1187**, or email at **techsupport@metra-autosound.com**. Before doing so, look over the instruction booklet a second time and ensure that the installation was performed exactly as the instruction booklet is stated. Have the vehicle apart and ready to perform troubleshooting steps before contacting Metra/Axxess Tech Support.



**KNOWLEDGE IS POWER**

Enhance your installation and fabrication skills by enrolling in the most recognized and respected mobile electronics school in our industry. Log onto [www.installerinstitute.com](http://www.installerinstitute.com) or call 800-354-6782 for more information and take steps toward a better tomorrow.



**Metra recommends MECP certified technicians**