



Kia Soul 2012-2013

KIT FEATURES

- DIN radio provision with pocket
- Painted matte black

KIT COMPONENTS

- A) Radio trim panel • B) Radio brackets • C) Pocket • D) (4) #8 x 3/8" Phillips screws

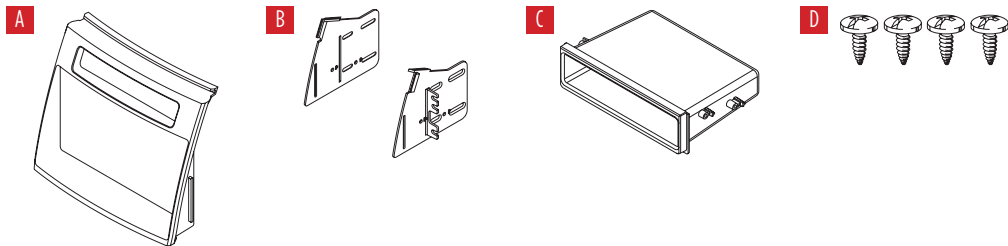

TABLE OF CONTENTS

Dash Disassembly	2
Kit Assembly	3

WIRING & ANTENNA CONNECTIONS (sold separately)

Wiring Harness: 70-7304 • AX-HYK1A1-SWC
& AX-HYK1A-SPDIF (for amplified models)
Antenna Adapter: Not required

TOOLS REQUIRED

- Panel removal tool • Phillips screwdriver

CAUTION! All accessories, switches, climate controls panels, and especially air bag indicator lights must be connected before cycling the ignition. Also, do not remove the factory radio with the key in the on position, or while the vehicle is running.

DASH DISASSEMBLY

1. Unclip and remove the panel (and speaker if equipped) from above the radio panel. (Figure A)
2. Unclip and remove the radio/climate control trim panel. (Figure B)

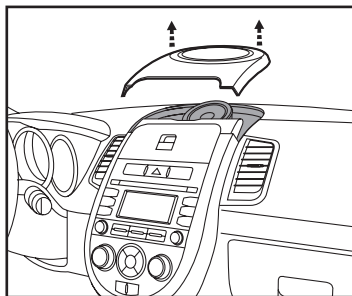

(Figure A)

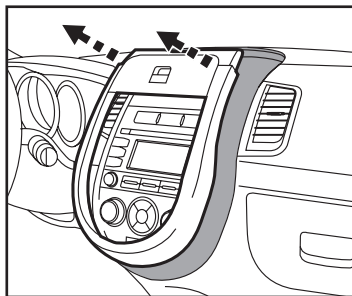

(Figure B)

3. Remove (4) Phillips screws securing the climate control panel. Slide the panel out and set to the side. (Figure C)
4. Remove (4) Phillips screws securing the radio. Slide the radio out, then unplug and remove the radio. (Figure C)
5. Remove (4) screws securing the hazard switch assembly from the radio, then secure the assembly to the 99-7349B radio trim panel using the same factory screws. (Figure D)

Continue to Kit Assembly

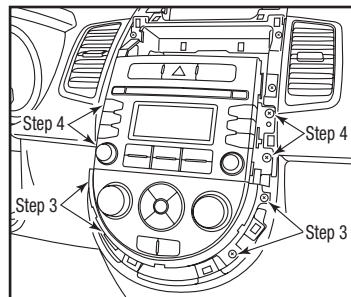

(Figure C)

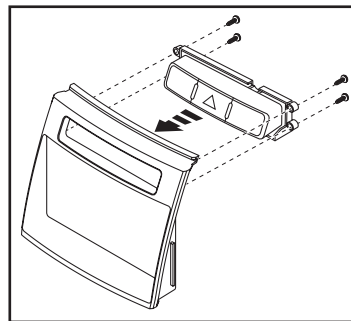

(Figure D)

KIT ASSEMBLY

1. Secure the *radio brackets* to the *pocket* using the (4) #8 x 3/8" Phillips screws provided. (Figure A)
2. Remove the metal DIN sleeve and trim ring from the aftermarket radio.
3. Slide the radio into the bracket/pocket assembly, then secure it using the screws supplied with the radio. (Figure B)
4. Clip the *radio trim panel* over the radio/pocket/bracket assembly. (Figure B)
5. Locate the factory wiring harness and antenna connector in the dash. Metra recommends using the proper mating adapters from Metra or AXXESS. Test the radio for proper operation.
6. Secure the radio assembly to the dash using the factory screws.
7. Reassemble the dash in reverse order of disassembly.

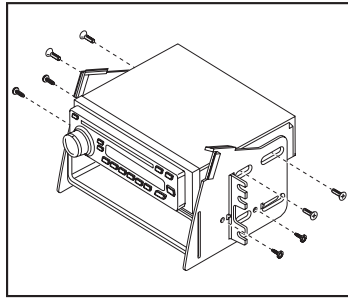

(Figure A)

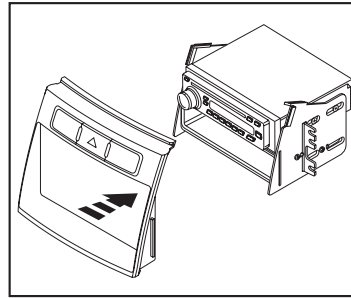

(Figure B)



99-7349B
INSTALLATION INSTRUCTIONS



IMPORTANT

If you are having difficulties with the installation of this product, please call our Tech Support line at 1-800-253-TECH. Before doing so, look over the instructions a second time, and make sure the installation was performed exactly as the instructions are stated. Please have the vehicle apart and ready to perform troubleshooting steps before calling.



KNOWLEDGE IS POWER

Enhance your installation and fabrication skills by enrolling in the most recognized and respected mobile electronics school in our industry. Log onto www.installerinstitute.com or call 800-354-6782 for more information and take steps toward a better tomorrow.



**Metra recommends MECP
certified technicians**



Kia Soul 2012-2013

CARACTERÍSTICAS DEL KIT

- Provisión de radio DIN con cavidad
- Pintura negro mate

COMPONENTES DEL KIT

- A) Panel de moldura de radio • B) Soportes del radio • C) Cavidad • D) (4) Tornillos Phillips #8 de 3/8"

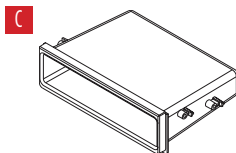
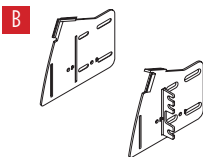
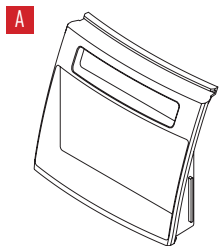

INDICE

Desmontaje del tablero	2
Ensamble del kit	3

CABLEADO Y CONEXIONES DE ANTENA

(se venden por separado)

Arnés de cableado: 70-7304 • AX-HYKIA1-SWC
y AX-HYKIA-SPDIF (para modelos amplificados)
Adaptador de antena: No se requiere

HERRAMIENTAS REQUERIDAS

- Herramienta para quitar paneles
- Destornillador Phillips

¡PRECAUCIÓN! Todos los accesorios, interruptores, paneles de controles de clima y especialmente las luces del indicador de las bolsas de aire deben estar conectados antes de ciclar la ignición. Además, no quite el radio de fábrica con la llave en la posición de encendido ni con el vehículo funcionando.

DESMONTAJE DEL TABLERO

1. Desenganche y quite el panel (y la bocina, si se incluye), de arriba del panel del radio. (Figura A)
2. Desenganche y quite el panel de la moldura del radio/control de clima. (Figura B)

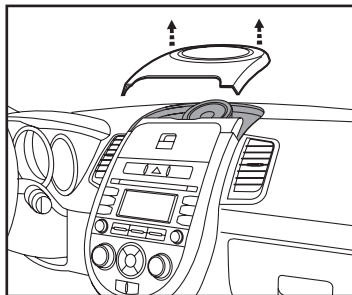

(Figura A)

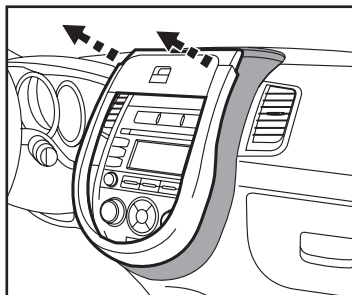

(Figura B)

3. Quite los (4) tornillos Phillips que sujetan el control de clima. Deslice el panel y colóquelo hacia un lado. (Figura C)
4. Quite los (4) tornillos Phillips que sujetan el radio. Deslice el radio hacia afuera, luego desconecte y retire la radio. (Figura C)
5. Retire (4) tornillos que sujetan el ensamble del interruptor de peligro de la radio, luego asegure el ensamble al panel de moldura de radio 99-7349B utilizando los mismos tornillos de fábrica. (Figura D)

Continúe con el *Ensamble del Kit*

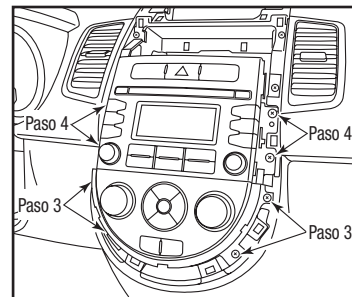

(Figura C)

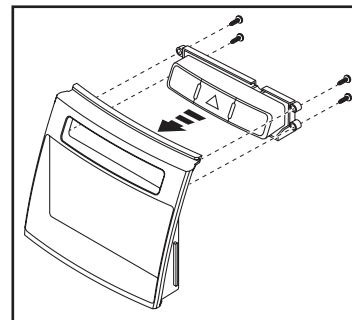

(Figura D)

ENSAMBLE DEL KIT

1. Atornille los soportes del radio al cavidad con los (4) tornillos Phillips #8 de 3/8" suministrados. (Figura A)
2. Quite la manga de metal DIN y el anillo de moldura del radio de mercado secundario.
3. Deslice el radio dentro del ensamble del soporte/cavidad, luego sujételo con los tornillos suministrados con el radio. (Figura B)
4. Clip del panel de moldura de radio sobre el ensamble de cavidad/soporte. (Figura B)
5. Localice el arnés de cableado de fábrica y el conector de la antena en el tablero. Metra recomienda que use adaptadores adecuados de acoplamiento de Metra y/o de AXCESS.
6. Asegure el ensamble de la radio al tablero con los tornillos de fábrica.
7. Vuelva a armar el tablero al revés de como lo desarmó.

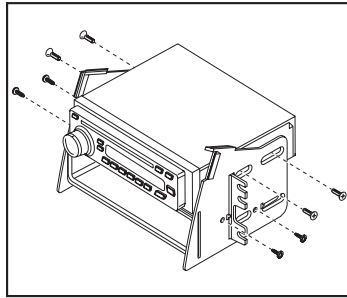

(Figura A)

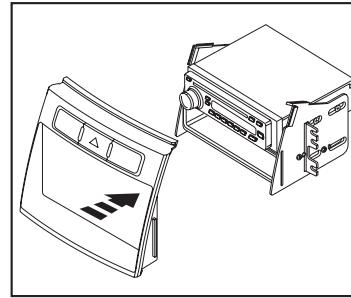

(Figura B)



99-7349B
INSTRUCCIONES DE INSTALACIÓN



IMPORTANTE

Si tiene dificultades con la instalación de este producto, llame a nuestra línea de soporte técnico al 1-800-253-TECH. Antes de hacerlo, revise las instrucciones por segunda vez y asegúrese de que la instalación se haya realizado exactamente como se indica en las instrucciones. Por favor tenga el vehículo desarmado y listo para ejecutar los pasos de resolución de problemas antes de llamar.



EL CONOCIMIENTO ES PODER

Mejore sus habilidades de instalación y fabricación inscribiéndose en la escuela de dispositivos electrónicos móviles más reconocida y respetada de nuestra industria. Regístrese en www.installerinstitute.com o llame al 800-354-6782 para obtener más información y avance hacia un futuro mejor.



Metra recomienda técnicos con certificación del Programa de Certificación en Electrónica Móvil (Mobile Electronics Certification Program, MECP).