



Nissan Sentra 2020-Up

Visit MetraOnline.com for more detailed information about the product and up-to-date vehicle specific applications

KIT FEATURES

- ISO DIN radio provision with pocket
- Painted with a gloss black face, silver trim, and a textured housing.

KIT COMPONENTS

- A) Radio housing (front) • B) Radio housing (rear) • C) Radio trim panel • D) Radio brackets • E) #4 x 3/8" Phillips screws (4)
- F) #6 x 3/8" Phillips screws (4) • G) Panel clips (3)

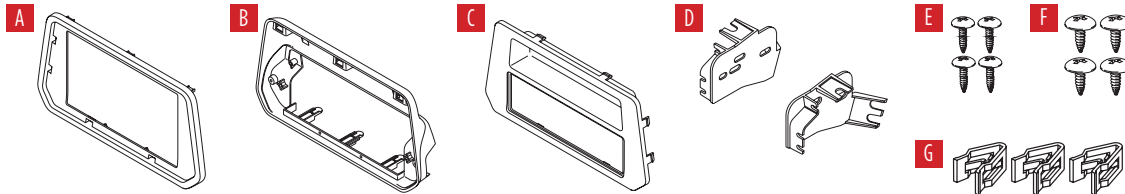

TABLE OF CONTENTS

Dash Disassembly	2
Kit Assembly	3

WIRING & ANTENNA CONNECTIONS (sold separately)

Wiring Harness: 70-7552

Antenna Adapter: 40-NI12

TOOLS REQUIRED

- Panel removal tool • Phillips screwdriver
- 10mm socket wrench

Attention! Let the vehicle sit with the key out of the ignition for a few minutes before removing the factory radio. When testing the aftermarket equipment, ensure that all factory equipment is connected before cycling the key to ignition.

DASH DISASSEMBLY

1. Unclip and remove the trim panel behind the radio. There are (4) clips securing this panel to the dash. Use caution as the front of the trim panel can easily be damaged. (Figure A)
Note: Dash vents may vary depending on Nissan model.
2. Remove (4) 10mm screws securing the radio. Take note that the lower radio brackets are angled inward, hiding the bottom (2) screws from being easily seen. Slide the radio out, then unplug and remove the radio. (Figure B)

Continue to Kit Assembly

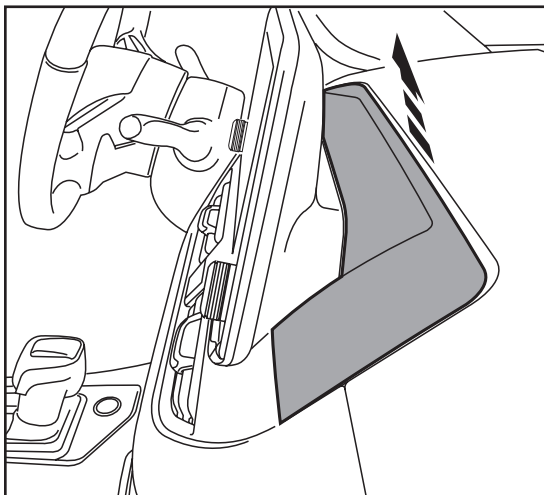

(Figure A)

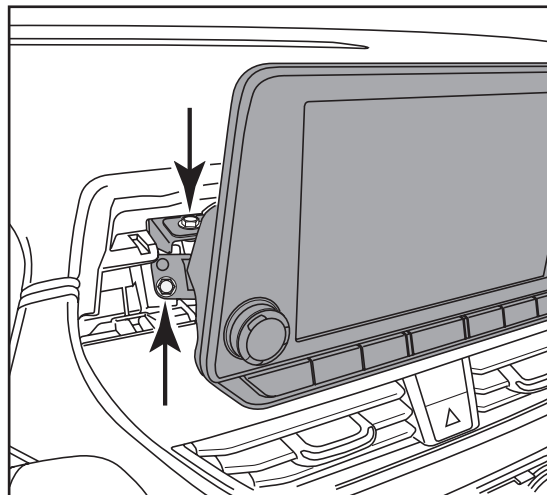

(Figure B)

KIT ASSEMBLY

1. Attach (3) **panel clips** provided onto the radio housing (front). (Figure A)
2. Snap the **radio housing (front)** to the **radio housing (rear)**, then secure using (4) #4 x 3/8" Phillips screws provided (Figure B)
3. Secure the **radio brackets** to the **radio housing** using (4) #6 x 3/8" Phillips screws provided. (Figure C)
4. Clip the **radio trim panel** onto the radio housing assembly. (Figure D)
5. Remove the metal DIN sleeve and trim ring from the aftermarket radio.

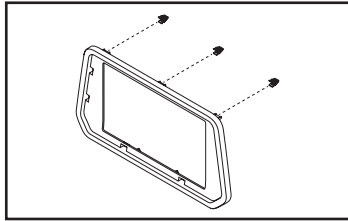

(Figure A)

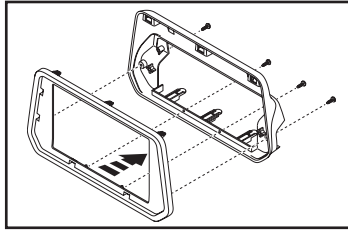

(Figure B)

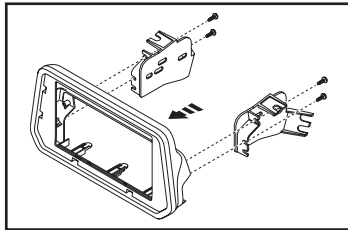

(Figure C)

6. Slide the radio into the radio housing assembly through the back, then secure it to the assembly using screws supplied with the radio. (Figure E)
7. Locate the factory wiring harness and antenna connector in the dash and complete all necessary connections to the radio. Metra recommends using the proper mating adapter from Metra and/or Axxess. Test the radio for proper operation.
8. Secure the radio assembly to the dash using the factory screws.
9. Snap the factory trim panel to the dash to complete the installation.

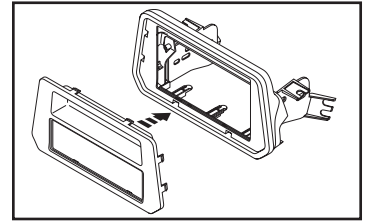

(Figure D)

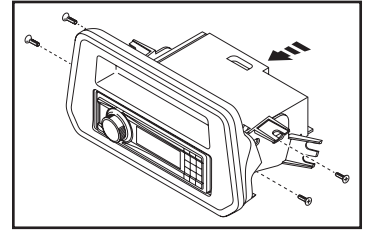

(Figure E)



99-7638
INSTALLATION INSTRUCTIONS



If you are having difficulties with the installation of this product, contact our Tech Support line either by phone at **386-257-1187**, or email at **techsupport@metra-autosound.com**. Before doing so, look over the instruction booklet a second time and ensure that the installation was performed exactly as the instruction booklet is stated. Have the vehicle apart and ready to perform troubleshooting steps before contacting Metra/Axxess Tech Support.



KNOWLEDGE IS POWER

Enhance your installation and fabrication skills by enrolling in the most recognized and respected mobile electronics school in our industry. Log onto www.installerinstitute.com or call 800-354-6782 for more information and take steps toward a better tomorrow.



Metra recommends MECP certified technicians