

AX-DSP T-Harness

The **Axxess T-harness** is a basic and simple plug-n-play harness for easy installation of the **AXDSP-X** or **AXDSP-L** (sold separately) for vehicle specific applications. Most T-harnesses created by Axxess will have an 8-pin harness, with the speaker wires pinned. If you are installing a 4-channel amplifier with one of the **AXDSP interfaces**, leave these connectors disconnected. The only reason for connecting these harnesses together would be if the **AXDSP interface** is being used for adding a subwoofer amplifier only. Some T-harnesses require additional wiring and/or installation steps, see page 2. Refer to page 3 for a pinout legend for the 20-pin harness, and also additional wiring and notes.

APPLICATIONS

Visit AxxessInterfaces.com for current application list.

TABLE OF CONTENTS

Installation Options	2
Installation	2
20-Pin Harness Pinout.....	3
Adding A Subwoofer To A Factory System.....	4
Adding A Full-Range Amp and Subwoofer To A Factory System	5

Visit AxxessInterfaces.com for more detailed information about the product and up-to-date vehicle specific applications.

Visit Metraonline.com or AxxessInterfaces.com for harness and interface options.

ATTENTION: With the key out of the ignition, disconnect the negative battery terminal before installing this product. Ensure that all installation connections, especially the air bag indicator lights, are plugged in before reconnecting the battery or cycling the ignition to test this product.

NOTE: Refer also to the instructions included with the aftermarket accessory before installing this device.

Adding a subwoofer to a factory system:

The diagram on **Page 4** shows the connections that need to be made to add a subwoofer to the factory system.

Note: RCA jacks sold separately.

Adding a full-range of amps and subwoofer to a factory system:

The diagram on **Page 5** shows the connections that need to be made to add: Subwoofer (RCA jacks sold separately)

Amplifier (SPDT **relay E-123** required) or

Additional Amp (RCA jacks sold separately).

Note: The interface provides a 12-volt 1-amp output to turn on aftermarket amp(s). If installing multiple amps, an SPDT automotive relay will be required if the amp turn-on current of all amps combined exceeds 1-amp. Use Metra part number **E-123** (sold separately) for best results.

1. Disassemble the dash, unplug all connectors, and then remove the factory radio.[†]
2. Install the **AXDSPH-TY4 vehicle T-harness** to the vehicle and make all necessary connections, but leave the amp turn-on wire disconnected.
3. Plug the **AXDSPH-TY4 vehicle T-harness** to the **AXDSPH-TY4 interface**.
4. Plug the **AXDSPH-TY4 interface harness** to the **AXDSPH-TY4 interface**.
5. Download the **AXDSP-XL app** from the Google Play Store or Apple App store.
6. Refer to the **AXDSP-X** or **AXDSP-L** for tuning instructions.

[†] For dash disassembly instructions, refer to metraonline.com. Enter the year, make, and model of the vehicle in the **Vehicle Fit Guide** and find instructions under Metra Radio Install kits.

20-PIN HARNESS PINOUT

Pin-1	Red	Accessory Power	Pin-11	Yellow	Battery Power
Pin-2	Brown	Not Applicable	Pin-12	Orange	Control Wire for the AX-BASSKNOB
Pin-3	Pink	CAN-HI (CAN +)	Pin-13	Blue/Pink	CAN-LO (CAN -)
Pin-4	Black/Yellow	Future Use	Pin-14	Black	Ground
Pin-5	White/Black	Front Left Speaker (-)	Pin-15	White	Front Left Speaker (+)
Pin-6	Gray/Black	Front Right Speaker (-)	Pin-16	Grey	Front Right Speaker (+)
Pin-7	Green/Black	Rear Left Speaker (-)	Pin-17	Green	Rear Left Speaker (+)
Pin-8	Purple/Black	Rear Right Speaker (-)	Pin-18	Purple	Rear Right Speaker (+)
Pin-9		RCA Input 5 (-)	Pin-19		RCA Input 5 (+)
Pin-10		RCA Input 6 (-)	Pin-20		RCA Input 6 (+)

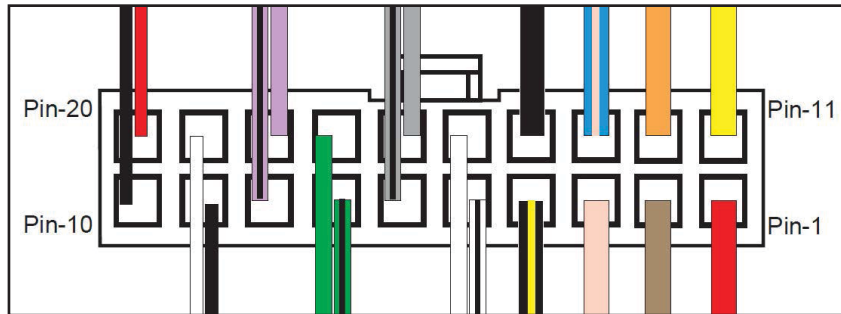

Wire View of Harness

ADDING A SUBWOOFER TO A FACTORY SYSTEM

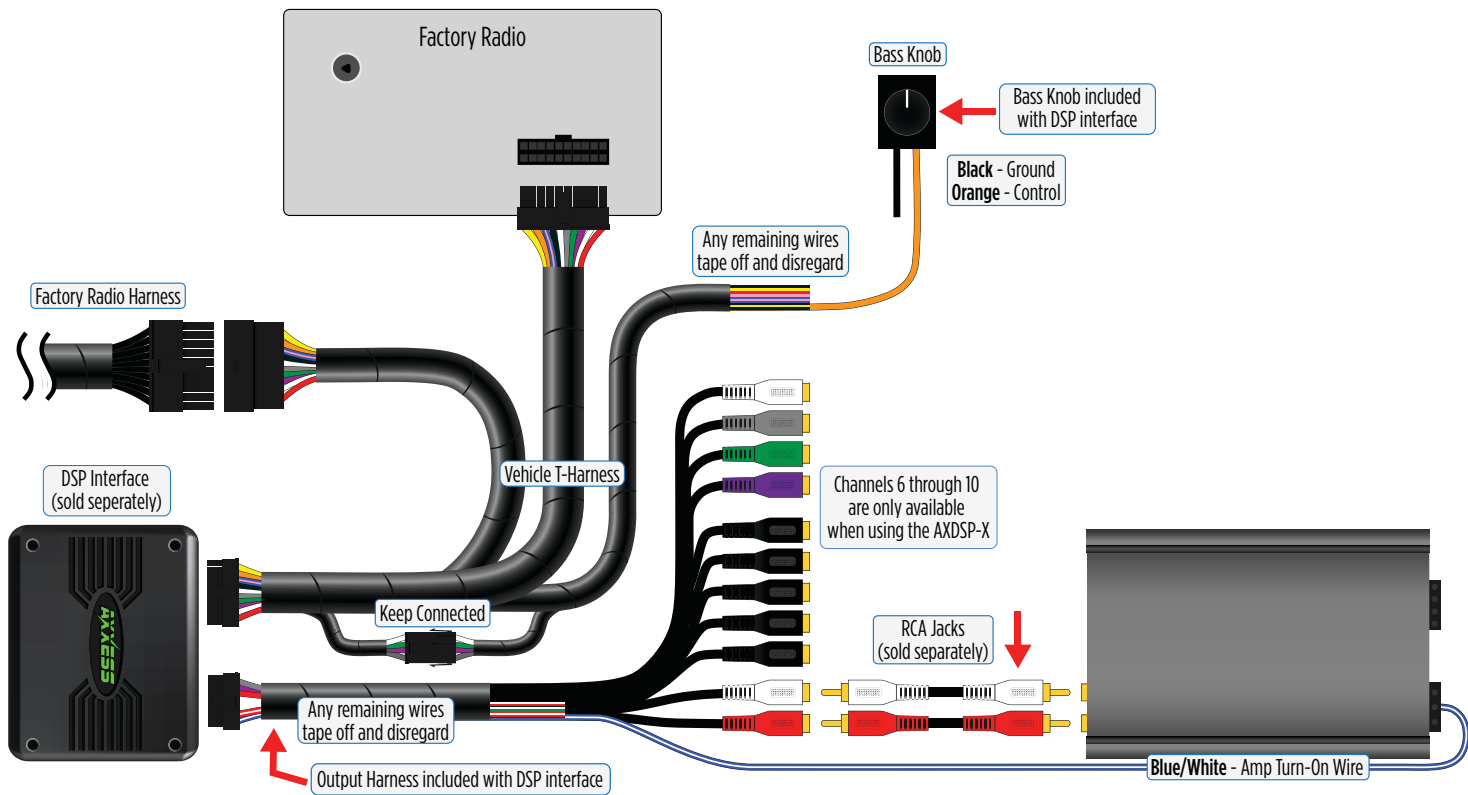

ADDING A FULL-RANGE AMP & SUBWOOFER TO A FACTORY SYSTEM

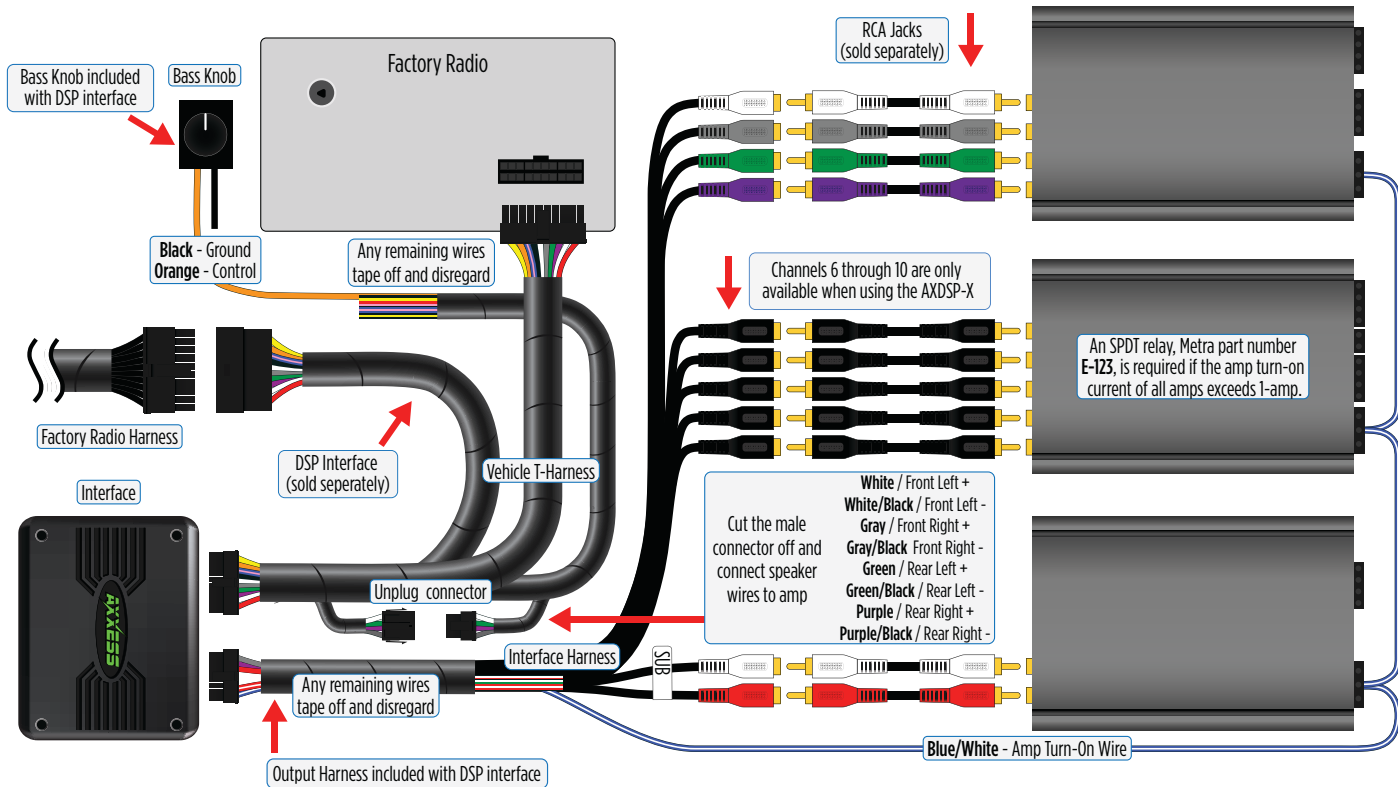



AXDSPH-TY4

INSTALLATION INSTRUCTIONS



Having difficulties? We're here to help.



Contact our Tech Support line at:

386-257-1187



Or via email at:

techsupport@metra-autosound.com

Tech Support Hours (Eastern Standard Time)

Monday - Friday: 9:00 AM - 7:00 PM

Saturday: 10:00 AM - 7:00 PM

Sunday: 10:00 AM - 4:00 PM



KNOWLEDGE IS POWER

Enhance your installation and fabrication skills by enrolling in the most recognized and respected mobile electronics school in our industry. Log onto www.installerinstitute.edu or call 386-672-5771 for more information and take steps toward a better tomorrow.



**Metra recommends MECP
certified technicians**