



INTERFACE COMPONENTS

- AXDSPL-HK2 interface
- LD-DSP-HYK1A2 interface harness
- AXDSPL-HK2 amp bypass harness
- AXBK-1 (bass knob)

MetraOnline.com may be used to assist with dash assembly instructions. Simply enter your Year, Make, Model vehicle into the vehicle fit guide and look for the Dash Kit Installation Instructions.

www.MetraOnline.com



Hyundai/Kia DSP Interface With Amp Bypass Harness

2011-2016

INTERFACE FEATURES

- Includes a DSP (Digital Signal Processor)
- 15 Band graphic EQ
- 4 inputs and 6 individually assignable outputs
- Independent equalization for front, rear, and sub
- Selectable low pass, band pass, and high pass filters
- Selectable crossover slopes; 12db, 24db, 36db, 48db
- Each channel can be delayed independently up to 10ms
- Clipping detection and limiting circuits
- Retains BlueLink/UVO voice prompts, with adjustable level
- Designed for SPDIF amplified models
- Includes an amp bypass harness
- Internal header port for adding interface modules
- Bass knob included for level control of subwoofer amp
- Settings adjusted via Bluetooth[®] in a smart device application (tablet or mobile phone), compatible with both Android and Apple devices
- Read, write, and store configurations for future recall
- Password protect feature available in the mobile app
- Micro-B USB updatable

TABLE OF CONTENTS

Connections.....	2
Installation	3
AXDSPL-BT Installation.....	4
AXDSPL-SP Installation.....	5
Mobile App.....	6-7
Specifications /Speaker Assignment QR code.....	8

TOOLS & INSTALLATION ACCESSORIES REQUIRED

- Crimping tool and connectors, or solder gun, solder, and heat shrink
- Tape
- Wire cutter
- Zip ties
- Multimeter

APPLICATIONS

Visit Axxessinterfaces.com for current application list

Google Play Store



Apple App Store

iOS 12.1 or higher



CONNECTIONS

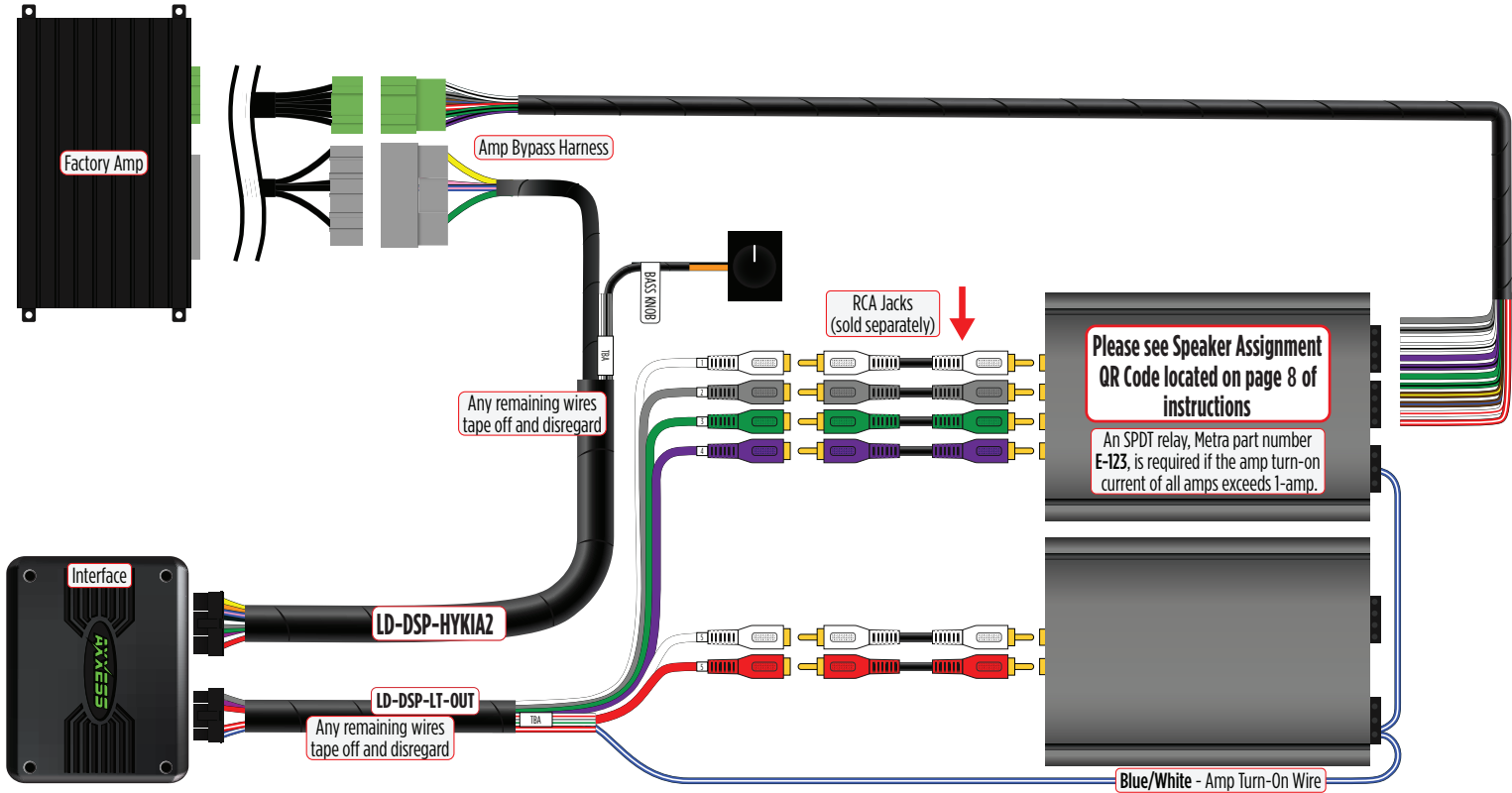

INSTALLATION

1. Locate the factory amp. Unplug and remove the amp.
2. Install the **AXDSPL-HK2 amp bypass harness** to the vehicle and make all necessary connections, but leave the amp turn-on wire disconnected.
3. Connect the **AXDSPL-HK2 amp bypass harness** to the **AXDSPL-HK2 interface**.
4. Connect the **AXDSPL-HK2 interface harness** to the **AXDSPL-HK2 interface**.
5. Download and install the **AX-DSP-XL app** from the **Google Play Store** or **Apple App Store**.
6. Cycle the ignition on.
7. Open the app then select the **Bluetooth Connection** tab. Follow the instructions to pair the mobile device to the interface. Refer to [page 8](#) for more information.
8. Scroll to the **Configuration** tab then select the vehicle type. Press the **Lock Down ‡** button to save the configuration. Refer to [page 9](#) for more information.
9. Connect the amp turn-on wire.

† Refer to [Metra online](#) for dash disassembly. If Metra makes a dash kit for the vehicle, disassembly will be within those instructions.

‡ Anytime the interface is locked down the key must be cycled off then back on.

10. Click the **Identify** button to confirm the interface is connected properly. A chime will be heard from the front left speaker. Test all functions of the installation for proper operation.

Note: The outputs may need to be configured within the **Outputs** tab.

11. Adjust the settings in the app as desired. Press the **Lock Down ‡** button to save any new configurations.

‡ Anytime the interface is locked down the key must be cycled off then back on

Note: The interface provides a 12-volt 1-amp output to turn on aftermarket amp(s). If installing multiple amps, an SPDT automotive relay will be required if the amp turn-on current of all amps combined exceeds 1-amp. Use Metra part number E-123 (sold separately) for best results.

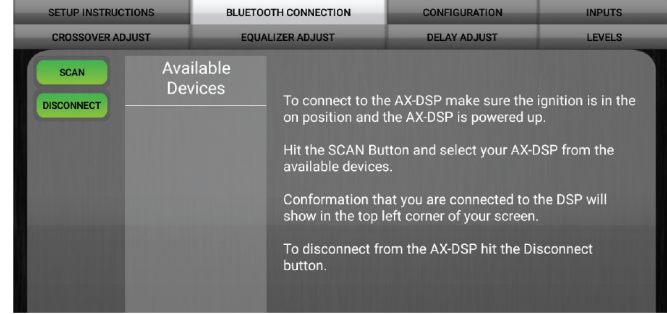

(Figure A)

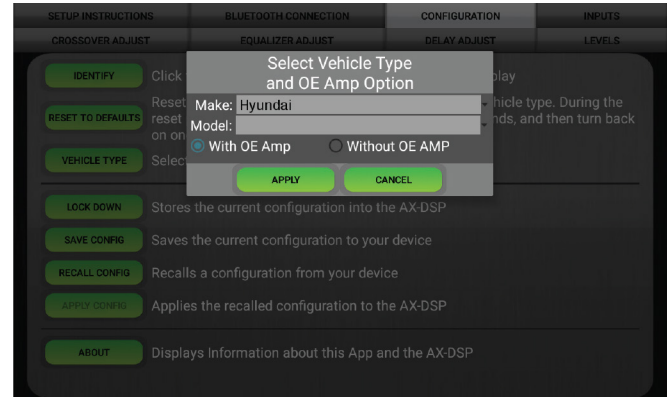

(Figure B)

BLUETOOTH STREAMING INTERFACE

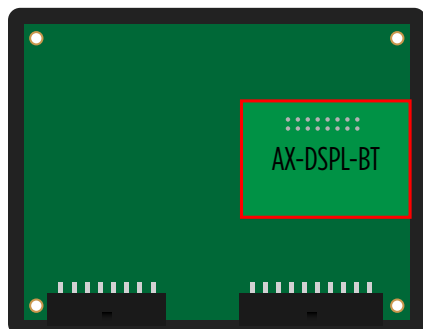
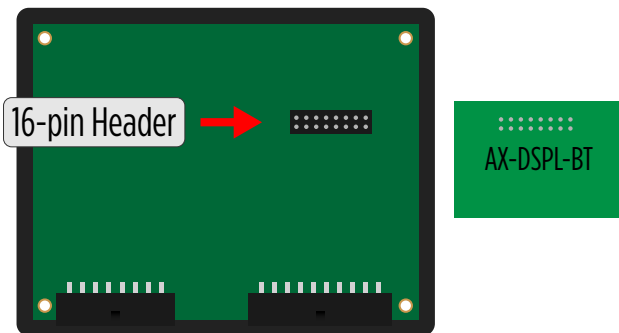

- The **AXDSPL-BT** Bluetooth streaming interface can be used to stream media directly to the interface.
- While streaming media the volume on the phone will be used. As an option, the **AXBK-1** (sold separately) can be used to control the volume.

Note: The bass knob included with the **AXDSPL-HK2** can be used if it will not be used to control a subwoofer.

1. **Important!** Unplug the interface from the vehicle.
2. Remove (4) Phillips screws securing the interface, then remove the top cover, exposing the circuit board within.
3. Locate the 16-pin header on the circuit board.
4. **Important!** Referencing how the **AXDSPL-BT** is laid out in the picture, carefully line up the header pins to the interface. Gently press down to secure.
Note: Both interfaces may be damaged if installed wrong.
5. Reinstall the top cover to complete the installation.

AXBK-1 Installation:

6. Connect the **Brown** wire from the interface to the **Orange** wire from the **AXBK-1**. Ground the **Black** wire from the **AXBK-1**.

Continued on the next page

TOSLINK DIGITAL OUTPUT

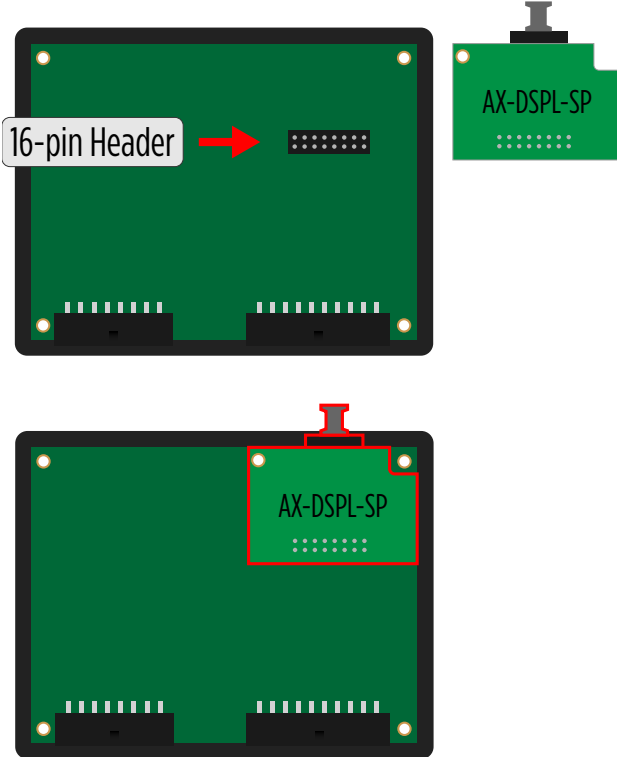

- The **AXDSPL-SP** Toslink digital output can be used for adding a digital output to the interface.
1. **Important!** Unplug the interface from the vehicle.
 2. Remove (4) Phillips screws securing the interface, then remove the top cover, exposing the circuit board within.
 3. Locate the 16-pin header on the circuit board.
 4. **Important!** Carefully line up the header pins to the **AXDSPL-SP**, with the Toslink port facing outward. Gently press down to secure.
Note: Both interfaces may be damaged if installed wrong.
 5. Reinstall the top cover provided with the **AXDSPL-SP** to complete the installation.

QUICK SETUP STEPS THROUGH AXDSP-XL APP

Google Play Store



Apple App Store

iOS 12.1 or higher



1. Download and install the AXDSP-XL app from the **Google Play Store** or **Apple App Store**.
2. Turn Vehicle Ignition on. Make sure the Remote Turn on lead is disconnected.
3. Open the app: Select **Bluetooth Connections** page.
 - Select **Scan**, all available AXDSP devices within range will be displayed. Select your AXDSP and hit connect. (Figure A)
4. Select the Configuration page.
 - Select **Vehicle Type** Icon
 - Select the Vehicle Make: ____ (Example: **Hyundai**)
 - Select the Vehicle's model: ____ (Example: **Genesis**)
 - Select **With OE Amp**
 - Hit **Apply** (Figure B)
5. Make sure radio volume is all the way down.
6. Connect the amp turn-on wire from the **AXDSP-HK2 harness** to the aftermarket amplifiers.

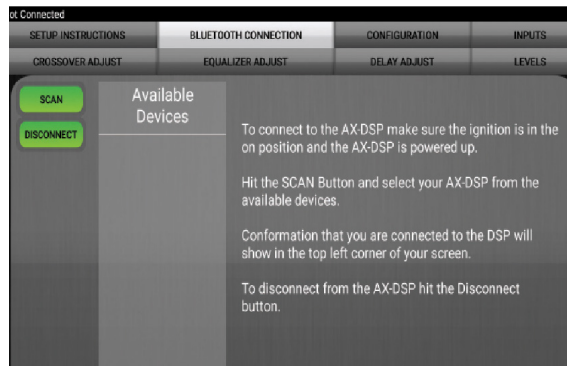

(Figure A)

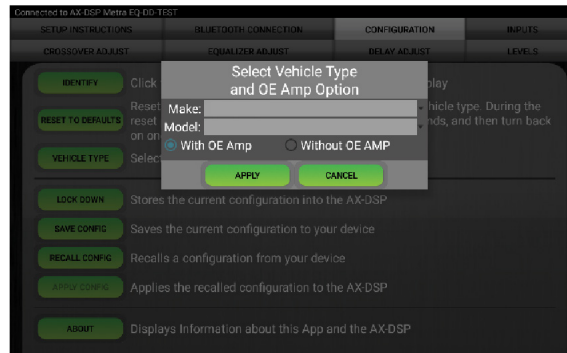

(Figure B)

QUICK SETUP STEPS THROUGH AXDSP-XL APP (CONT.)

- From the **Configuration** page click the **Identify** button to confirm that the **AXDSP-HK2** is connected properly. If so, a chime will be heard from the front left speaker.
- Press the **Lock Down** button to save the configuration. (Do not turn ignition off until this process is completed) (Figure C)
- Select the **Bluetooth Configurations** page and disconnect the DSPX.
- Turn ignition off, close all door then lock vehicle using the key fob. The vehicle will need to sit uninterrupted for 10 minutes while the vehicle goes to sleep. (Make sure Key fob is 15 feet away from the vehicle)
- Unlock Vehicle, turn ignition on and test radio's functions.
- Adjust the DSP settings in the app as desired. Refer to the instructions under the **Setup Instructions** tab, or online at Axxessinterfaces.com for an explanation of each tab in the app.

Locking Down Data

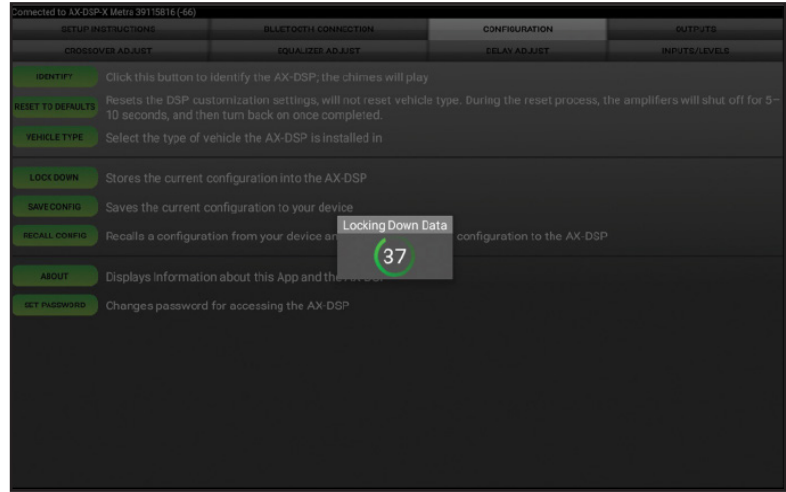

(Figure C)

**Last and the most important:
You MUST lock down your
configuration and cycle the key!!!**

SPECIFICATIONS

Input Impedance	1M Ohm
Input Channels	6
Input Options	High Level or Low Level
Input Type	Differential balanced
Input Voltage (high level range)	0 - 28-volts (peak-to-peak)
Input Voltage (low level range)	0 - 4.9-volts (peak-to-peak)
Output Channels	6
Output Voltage	Up to 5-volts RMS
Output Impedance	50 Ohms
Equalizer Type	15 Band Graphic EQ, +/- 10dB
THD	<0.03%
Frequency Response	20Hz - 20kHz

Crossover Filter	Low pass, band pass, high pass
Crossover Frequency	Selectable 20hz to 20khz
Crossover Slope	12db/24db/36db/48db
Crossover Type	Linkwitz-Riley
Sampling	48kHz
S/N Ratio	105dB @ 5-volts RMS
Operating Voltage	10-16 volts DC
Standby Current Draw	7mA
Operation Current Draw	150mA
Adjustments/Controls	Application via Bluetooth
Remote Output	12 volts DC (signal sense or with ignition)

Speaker Assignment



Visit [AxxessInterfaces.com](https://www.AxxessInterfaces.com) for more detailed information about the product and up-to-date vehicle specific applications

Having difficulties? We're here to help.



Contact our Tech Support line at:
386-257-1187



Or via email at:
techsupport@metra-autosound.com

Tech Support Hours (Eastern Standard Time)

Monday - Friday: 9:00 AM - 7:00 PM

Saturday: 10:00 AM - 5:00 PM

Sunday: 10:00 AM - 4:00 PM



Metra recommends MECP certified technicians